

SHARP

Important

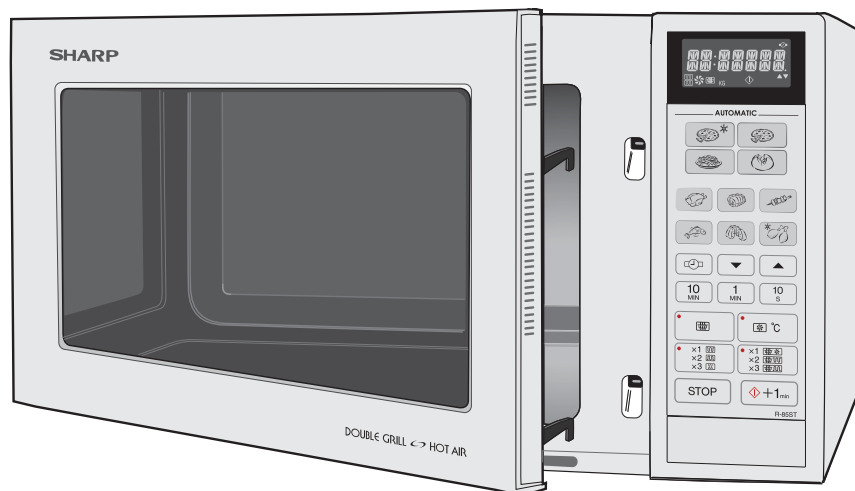

R-85ST MICROWAVE OVEN WITH TOP & BOTTOM GRILLS AND CONVECTION

OPERATION MANUAL

OPERATION MANUAL

This operation manual contains important information which you should read carefully before using your microwave oven.

IMPORTANT: There may be a serious risk to health if this operation manual is not followed or if the oven is modified so that it operates with the door open.

900 W (IEC 60705)

ENGLISH



GB Dear Customer,

Congratulations on acquiring your new combination microwave oven with top & bottom grill and convection, which from now on will make your kitchen chores considerably easier.

You will be pleasantly surprised by the kinds of things you can do with a microwave.

Not only can you use it for rapid defrosting or heating up of food, you can also prepare whole meals.

In our test kitchen our microwave team has gathered together a selection of the most delicious international recipes which are quick and simple to prepare.

Be inspired by the recipes we have included and prepare your own favourite dishes in your microwave oven.

There are so many advantages to having a microwave oven which we are sure you will find exciting:

- Food can be prepared directly in the serving dishes, leaving less to wash up.
- Shorter cooking times and the use of little water and fat ensure that many vitamins, minerals and characteristic flavours are preserved.

We advise you to read the cookery book guide and operating instructions carefully.

You will then easily understand how to use your oven.

Enjoy using your microwave oven and trying out the delicious recipes.

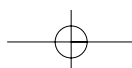
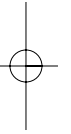
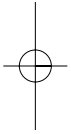

GB

**Attention:**

Your product is marked with this symbol. It means that used electrical and electronic products should not be mixed with general household waste. There is a separate collection system for these products.

A. Information on Disposal for Users (private households)

1. In the European Union

Attention: If you want to dispose of this equipment, please do not use the ordinary dust bin!

Used electrical and electronic equipment must be treated separately and in accordance with legislation that requires proper treatment, recovery and recycling of used electrical and electronic equipment.

Following the implementation by members states private households within the EU states may return their used electrical and electronic equipment to designated collection facilities free of charge*.

In some countries* your local retailer may also take back your old product free of charge if you purchase a similar new one.

*) Please contact your local authority for further details.

If your used electrical or electronic equipment has batteries or accumulators, please dispose of these separately beforehand according to local requirements.

By disposing of this product correctly you will help ensure that the waste undergoes the necessary treatment, recovery and recycling and thus prevent potential negative effects on the environment and human health which could otherwise arise due to inappropriate waste handling.

2. In other Countries outside the EU

If you wish to discard this product, please contact your local authorities and ask for the correct method of disposal.

For Switzerland: Used electrical or electronic equipment can be returned free of charge to the dealer, even if you don't purchase a new product. Further collection facilities are listed on the homepage of www.swico.ch or www.sens.ch.

B. Information on Disposal for Business Users

1. In the European Union

If the product is used for business purposes and you want to discard it:

Please contact your SHARP dealer who will inform you about the take-back of the product. You might be charged for the costs arising from take-back and recycling. Small products (and small amounts) might be taken back by your local collection facilities.

For Spain: Please contact the established collection system or your local authority for take-back of your used products.

2. In other Countries outside the EU

If you wish to discard of this product, please contact your local authorities and ask for the correct method of disposal.

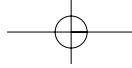

 **CONTENTS**

INFORMATION ON PROPER DISPOSAL1
OVEN AND ACCESSORIES3
CONTROL PANEL4
IMPORTANT SAFETY INSTRUCTIONS5-7
INSTALLATION7
BEFORE OPERATION8
USING THE STOP KEY8
ENERGY SAVE MODE8
SETTING THE CLOCK9
MICROWAVE POWER LEVELS9
MICROWAVE COOKING10
HEATING WITHOUT FOOD10
GRILL COOKING11
CONVECTION COOKING12-13
DUAL COOKING14-15
OTHER CONVENIENT FUNCTIONS16-18
AUTOMATIC OPERATION19
AUTOMATIC COOKING CHART20-21
AUTOMATIC DEFROST CHART22
CARE AND CLEANING23
SERVICE CALL CHECK24
SERVICE ADDRESSES25-30
SPECIFICATIONS31

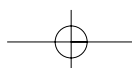
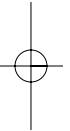
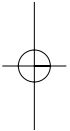

OVEN AND ACCESSORIES

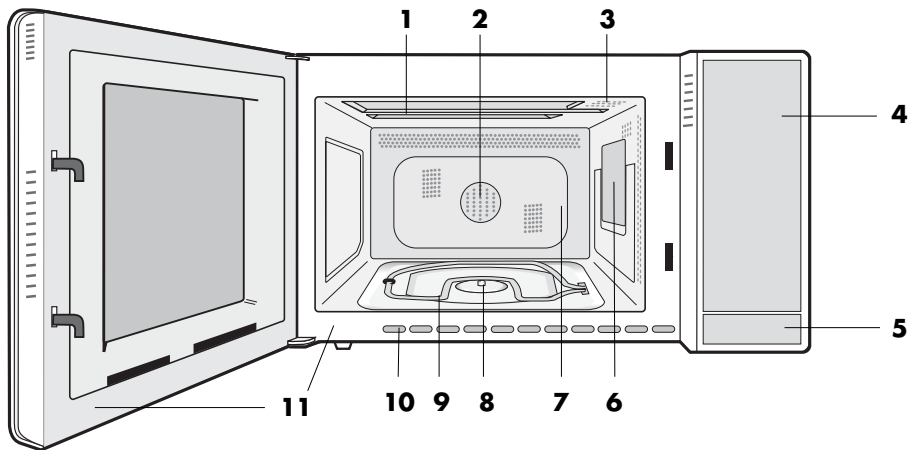

- 1 Grill heating element (top grill)
- 2 Convection Fan
- 3 Oven lamp
- 4 Control panel
- 5 Door open button
- 6 Waveguide cover
- 7 Oven cavity
- 8 Turntable motor shaft
- 9 Grill heating element (bottom grill)
- 10 Ventilation openings
- 11 Door seals and sealing surfaces
- 12 Power cord
- 13 Outer cabinet

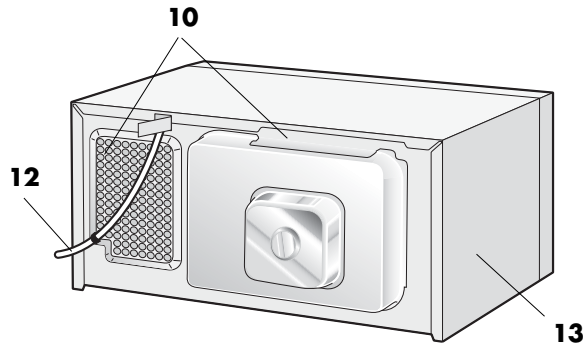

ACCESSORIES:

Check to make sure the following accessories are provided:

14 Turntable **15** Low rack **16** High rack

Place the turntable over the turntable shaft in the floor of the cavity.

Before first using the turntable and racks, clean with mild soapy water.

Do not cut or scratch the turntable.

Warning:

The accessories (e.g. turntable) will become very hot during **GRILL, DUAL, CONVECTION** and **AUTOMATIC** (except Defrost) modes. Always use thick oven gloves when removing the food or turntable from the oven to prevent burns.

NOTE: When you order accessories, please mention the following two items: Part name and model name to your dealer or SHARP authorised service agent.

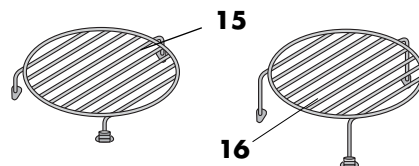
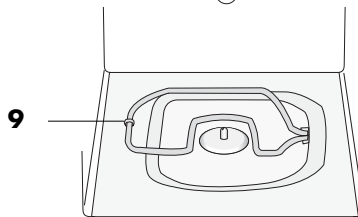
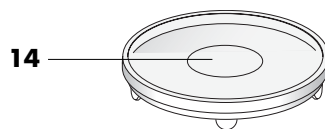

CONTROL PANEL

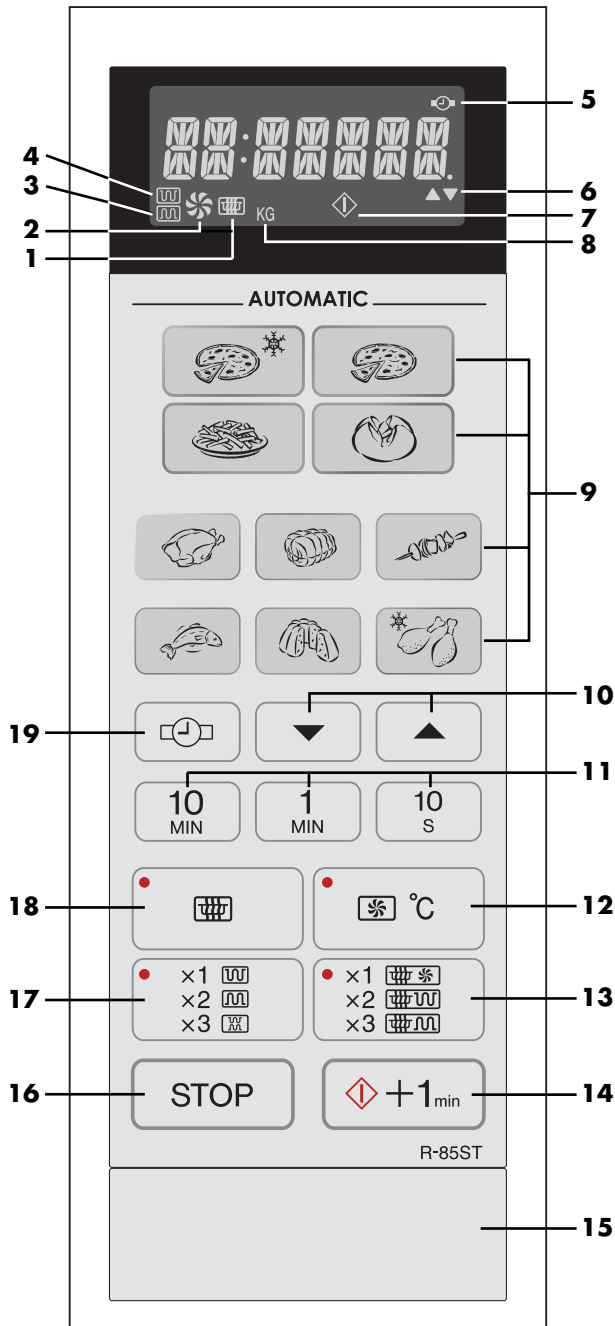

Digital display and indicators:

1. **MICROWAVE** indicator
2. **CONVECTION** indicator
3. **BOTTOM GRILL** indicator
4. **TOP GRILL** indicator
5. **CLOCK SET** indicator
6. **LESS/MORE** indicators
7. **COOKING IN PROGRESS** indicator
8. **WEIGHT (kg)** indicator

Operating keys:

9. **AUTOMATIC** keys
10. **LESS/MORE** keys
11. **TIME** keys
12. **CONVECTION** key
Press to change the convection setting
13. **DUAL MODE** key:
1 PRESS = MICROWAVE & CONVECTION
2 PRESSES = MICROWAVE & TOP GRILL
3 PRESSES = MICROWAVE & BOTTOM GRILL
14. **START/+ 1 min** key
15. **DOOR OPEN** button
16. **STOP** key
17. **GRILL MODE** key:
1 PRESS = TOP GRILL
2 PRESSES = BOTTOM GRILL
3 PRESSES = TOP & BOTTOM GRILL
18. **MICROWAVE POWER LEVEL** key
Press to change the microwave power setting
19. **CLOCK SETTING** key

IMPORTANT SAFETY INSTRUCTIONS



IMPORTANT SAFETY INSTRUCTIONS: READ CAREFULLY AND KEEP FOR FUTURE REFERENCE

To avoid the danger of fire

The microwave oven should not be left unattended during operation. Power levels that are too high or cooking times that are too long may overheat foods resulting in a fire.

In cases where the oven is to be installed into a kitchen cabinet, the installation frame EBR-47ST licensed by SHARP must be used. This is available from your dealer. Refer to the frame installation instructions or ask your dealer for the proper instruction procedure. Only the use of this frame will guarantee the safety and quality of the product. The electrical outlet must be readily accessible so that the unit can be unplugged easily in an emergency.

The AC power supply must be 230 V, 50 Hz, with a minimum 16 A distribution line fuse, or a minimum 16 A distribution circuit breaker.

It is recommended that a separate circuit serving only this appliance be provided.

Do not place the oven in areas where heat is generated. For example, close to a conventional oven. Do not install the oven in an area of high humidity or where moisture may collect.

Do not store or use the oven outdoors.

If food being heated begins to smoke, DO NOT OPEN THE DOOR. Turn off and unplug the oven and wait until the food has stopped smoking. Opening the door while food is smoking may cause a fire.

Use only microwave-safe containers and utensils. See Page X.

Do not leave the oven unattended when using disposable plastic, paper or other combustible food containers.

Clean the waveguide cover, the oven cavity and the turntable after use. These must be dry and free from grease. Built-up grease may overheat and begin to smoke or catch fire.

Do not place flammable materials near the oven or ventilation openings. Do not block the ventilation openings.

Remove all metallic seals, wire twists, etc., from food and food packages. Arcing on metallic surfaces may cause a fire.

Do not use the microwave oven to heat oil for deep frying. The temperature cannot be controlled and the oil may catch fire.

To make popcorn, use only special microwave popcorn makers.

Do not store food or any other items inside the oven.

Check the settings after you start the oven to ensure the oven is operating as desired.

See the corresponding hints in the cookery book section.

To avoid the possibility of injury

WARNING:

Do not operate the oven if it is damaged or malfunctioning. Check the following before use:

- The door; make sure the door closes properly and ensure it is not misaligned or warped.
- The hinges and door safety latches; check to make sure they are not broken or loose.
- The door seals and sealing surfaces; ensure that they have not been damaged.
- Inside the oven cavity or on the door; make sure there are no dents.
- The power supply cord and plug; ensure that they are not damaged.

Never adjust, repair or modify the oven yourself. It is hazardous for anyone other than a competent person to carry out any service or repair operation which involves the removal of a cover which gives protection against exposure to microwave energy.

Do not operate the oven with the door open or alter the door safety latches in any way.

Do not operate the oven if there is an object between the door seals and sealing surfaces.

Do not allow grease or dirt to build up on the door seals and adjacent parts. Clean the oven at regular intervals and remove any food deposits. Follow the instructions for "Care and Cleaning" on page 23. Failure to maintain the oven in a clean condition could lead to a deterioration of the surface that could adversely affect the life of the appliance and possibly result in a hazardous situation.

Individuals with PACEMAKERS should check with their doctor or the manufacturer of the pacemaker for precautions regarding microwave ovens.



IMPORTANT SAFETY INSTRUCTIONS

To avoid the possibility of electric shock

Under no circumstances should you remove the outer cabinet.

Never spill or insert any objects into the door lock openings or ventilation openings. In the event of a spill, turn off and unplug the oven immediately, and call an authorised SHARP service agent.

Do not immerse the power supply cord or plug in water or any other liquid.

Do not let the power supply cord hang over the edge of a table or work surface.

Keep the power supply cord away from heated surfaces, including the rear of the oven.

Do not attempt to replace the oven lamp yourself or allow anyone who is not an electrician authorised by SHARP to do so. If the oven lamp fails, please consult your dealer or an authorised SHARP service agent.

If the power supply cord of this appliance is damaged, it must be replaced with a special cord. The exchange must be made by an authorised SHARP service agent.

To avoid the possibility of explosion and sudden boiling:

WARNING: Liquids and other foods must not be heated in sealed containers since they are liable to explode.

Never use sealed containers. Remove seals and lids before use. Sealed containers can explode due to a build up of pressure even after the oven has been turned off.

Take care when microwaving liquids. Use a wide-mouthed container to allow bubbles to escape.

Microwave heating of beverages can result in delayed eruptive boiling, therefore care has to be taken when handling the container.

To prevent sudden eruption of boiling liquid and possible scalding:

1. Stir liquid prior to heating/reheating.
2. It is advisable to insert a glass rod or similar utensil into the liquid whilst reheating.
3. Let liquid stand for at least 20 seconds in the oven at the end of cooking time to prevent delayed eruptive boiling.

Do not cook eggs in their shells, and whole hard boiled eggs should not be heated in microwave ovens since they may explode even after microwave cooking has ended. To cook or reheat eggs which have not been scrambled or mixed, pierce the yolks and the whites, or the eggs may explode. Shell and slice hard boiled eggs before reheating them in the microwave oven.

Pierce the skin of such foods as potatoes, sausages and fruit before cooking, or they may explode.

To avoid the possibility of burns

Use pot holders or oven gloves when removing food from the oven to prevent burns.

Always open containers, popcorn makers, oven cooking bags, etc., away from the face and hands to avoid steam burns.

To avoid burns, always test food temperature and stir before serving and pay special attention to the temperature of food and drink given to babies, children or the elderly.

Temperature of the container is not a true indication of the temperature of the food or drink; always check the food temperature.

Always stand back from the oven door when opening, to avoid burns from escaping steam and heat.

Slice stuffed baked foods after heating to release steam and avoid burns.

Keep children away from the door to prevent them burning themselves.

Do not touch the oven door, outer cabinet, rear cabinet, oven cavity, ventilation openings, accessories and dishes during **GRILL**, **CONVECTION**, **DUAL** and **AUTOMATIC** modes (except AUTOMATIC DEFROST) as they will become hot. Before cleaning make sure they are not hot.

To avoid misuse by children

WARNING: Only allow children to use the oven without supervision when adequate instructions have been given so that the child is able to use the oven in a safe way and understands the hazards of improper use.

Do not lean or swing on the oven door. Do not play with the oven or use it as a toy.

Children should be taught all important safety instructions: use of pot holders, careful removal of food coverings; paying special attention to packaging (e.g. self-heating materials) designed to make food crisp, as they may be extra hot.

IMPORTANT SAFETY INSTRUCTIONS

Other warnings

Never modify the oven in any way.

Do not move the oven while it is in operation.

This oven is for home food preparation only and may only be used for cooking food. It is not suitable for commercial or laboratory use.

To promote trouble-free use of your oven and avoid damage.

Never operate the oven when it is empty except where recommended in the operation manual, see Page 10. Doing so may damage the oven.

When using a browning dish or self-heating material, always place a heat-resistant insulator such as a porcelain plate under it to prevent damage to the turntable due to heat stress. The preheating time specified in the dish's instructions must not be exceeded.

Do not use metal utensils, which reflect microwaves and may cause electrical arcing. Do not put cans in the oven.

Use only the turntable designed for this oven. Do not use the oven without the turntable.

Do not place anything on the outer cabinet during operation.

Do not use plastic containers for microwaving if the oven is still hot from using the **GRILL**, **CONVECTION**, **DUAL** and **AUTOMATIC** modes (except AUTOMATIC DEFROST) because they may melt. Plastic containers must not be used during above modes unless the container manufacturer says they are suitable.

NOTE:

If you are unsure how to connect your oven, please consult an authorised, qualified electrician.

Neither the manufacturer nor the dealer can accept any liability for damage to the oven or personal injury resulting from failure to observe the correct electrical connection procedure.

Water vapour or drops may occasionally form on the oven walls or around the door seals and sealing surfaces. This is a normal occurrence and is not an indication of microwave leakage or a malfunction.

INSTALLATION

1. Remove all packing materials from the inside of the oven cavity. Discard the loose polythene sheet from between the door and cavity. Remove the feature sticker, if attached, from the outside of the door.

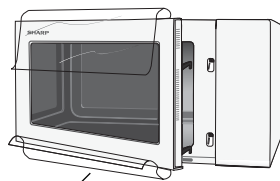

Remove this film

2. Check the oven carefully for any signs of damage.
3. Place the oven on a flat, level surface strong enough to support the oven's weight plus the heaviest item likely to be cooked.

4. **The oven door may become hot during cooking. Place or mount the oven so that the bottom of the oven is 85 cm or more above the floor. Keep children away from the door to prevent them burning themselves.**

5. **Do not allow the power supply cord to run over any hot or sharp surfaces, such as the hot air vent area at the top rear of the oven.**

6. Ensure there is a minimum of free space above the oven of 19 cm.

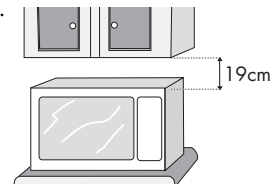

7. Securely connect the plug of the oven to a standard earthed (grounded) household electrical outlet.



BEFORE OPERATION

Your oven has an energy save mode.

Plug in the oven. Nothing will appear on the display at this time.

1. Open the door.
The oven display will show "ENERGY SAVE MODE".
2. Close the door.
The display will show ".0".
If you set the clock, "energy save mode" does not work.
If you keep "energy save mode" go to step 4.
3. Set the clock (See page 9).
4. Heat the oven without food (See page 10).



USING THE STOP KEY

STOP

Use the **STOP** key to:

1. Erase a mistake during programming.
2. Stop the oven temporarily during cooking.
3. Cancel a programme during cooking, press the **STOP** key twice.



ENERGY SAVE MODE

Your oven comes set for the energy save mode. If you do nothing for 2 minutes after a preceding operation, i.e. plugging in or at the end of cooking, the power will go off automatically. To restore power on, open and then close the door. If you set the clock, energy save mode does not work.

To start energy save mode, follow the instructions below.

Example:

To start the energy save mode, (the current time is 23:35):

1. Make sure the correct time appears on the display.
2. Press the **CLOCK SETTING** key.
3. Press the **1 MIN** key once.
4. Press **START/+1min** key. The power will be off and the display will show nothing.



Display:



SETTING THE CLOCK



There are two setting modes: 12 hour clock and 24 hour clock.

1. To set the 12 hour clock, press the **CLOCK SETTING** key once, as in Step 1 opposite.
2. To set the 24 hour clock, press the **CLOCK SETTING** key twice, as in Step 2 opposite.

Step 1.



x1

Step 2.



x2

Example: To set the 24 hour clock to 23:35:

1. Choose the 24 hour clock by pressing the **CLOCK SETTING** key twice.
2. Set the hours: Press the **10 MIN** key twice. Press the **1 MIN** key three times.
3. Change from hours to mins by pressing the **CLOCK SETTING** key once.



x2



x2



x3



x1

4. Set the minutes: Press **10 MIN** key three times. Press **1 MIN** key five times.



x3



x5



x1



5. Start the clock.

Check the display.

NOTES:

1. Press the **STOP** key if you make a mistake during programming.
2. If the oven is in cooking or minute timer mode and you wish to know the time of day, touch the **CLOCK SETTING** key. As long as your finger is touching the key, the time of day will be displayed.
3. If the electrical power supply to your microwave oven is interrupted, plug in the oven again, then open and close the door. The display will show "ENERGY SAVE MODE".
4. When you want to reset the time of day, follow the above example again.
5. If you do not set the clock, press the **STOP** key once will appear on the display. When the operation of the oven is finished, will reappear on the display instead of the time of day.
6. If you set the clock, energy save mode does not work.

If this occurs during cooking, the programme will be erased. The time of day will also be erased.

MICROWAVE POWER LEVELS



Your oven has 5 power levels. To choose the power level, follow the advice given in the cookbook.

900 WATT = 100 % output

630 WATT = 70 % output

450 WATT = 50 % output

270 WATT = 30 % output

90 WATT = 10 % output

- To set the power, touch the **MICROWAVE POWER LEVEL** key until the desired level is displayed.
- If the **MICROWAVE POWER LEVEL** key is touched once, will be displayed. If you miss your desired level, continue touching the **MICROWAVE POWER LEVEL** key until you reach the level again.
- **If the level is not selected, the level 900 W (100 %) is automatically set.**



MICROWAVE COOKING

Your oven can be programmed for up to 99.90 minutes. (99.90).

Example: Suppose you want to heat soup for 2 minutes and 30 seconds on 630 W microwave power.

1. Set the time:
Press **1 MIN** key twice and the **10 SEC** key three times.
 2. Choose desired power
630 W by pressing **MICROWAVE POWER LEVEL** key twice.
 3. Start cooking.
- Check the display**

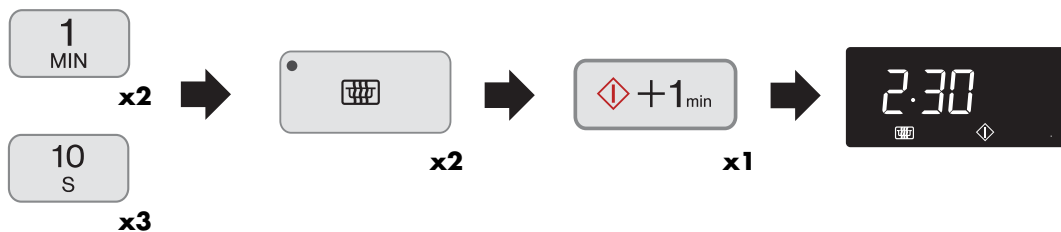

NOTES:

1. When the door is opened during the cooking process, the cooking time on the digital display stops automatically. The cooking time starts to count down again when the door is closed and the **START/+1 min** key is pressed.
2. If you wish to know the power level during cooking, press the **MICROWAVE POWER LEVEL** key. As long as your finger is pressing the **MICROWAVE POWER LEVEL** key, the power level will be displayed.
3. When the operation of the oven is finished, the time of day will reappear, if set, on the display.



HEATING WITHOUT FOOD

You may detect smoke or a burning smell when using the grill(s), dual grill or convection for the first time. This is normal and not a sign that the oven is out of order.

To avoid this problem, when first using the oven, operate both top and bottom grills without food for 20 minutes.

IMPORTANT: During grill operation, to allow smoke or smells to disperse open a window or switch the kitchen ventilation on. Make sure there is no food in the oven.

1. Enter the required heating time (20 min) by pressing the **10 MIN** key twice.
 2. Press the **GRILL MODE** key three times.
 3. Start heating.
- Check the display**

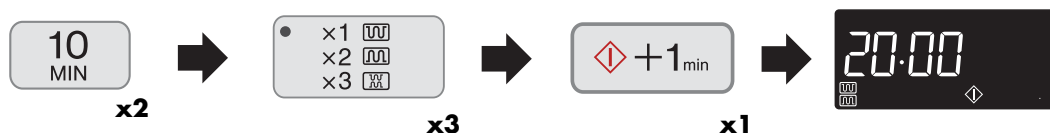

The oven will count down. When the oven has finished cooking, open the door to cool the oven cavity.

WARNING:

The oven door, outer cabinet and oven cavity will become hot. Take care to avoid burns when cooling the oven down after operation.

GRILL COOKING



Your oven has 2 grill heating elements, and a combination of 3 grill cooking modes. Input the time first then select the desired grill mode by pressing the **GRILL MODE** key as indicated below.

Press GRILL MODE key	GRILL HEATING ELEMENT IN USE	SYMBOL
<ul style="list-style-type: none"> • x1 x2 x3 x1	Top Grill	
<ul style="list-style-type: none"> • x1 x2 x3 x2	Bottom Grill	
<ul style="list-style-type: none"> • x1 x2 x3 x3	Top & Bottom Grill together	

Example:

Suppose you want to cook for 5 minutes using the TOP GRILL only.

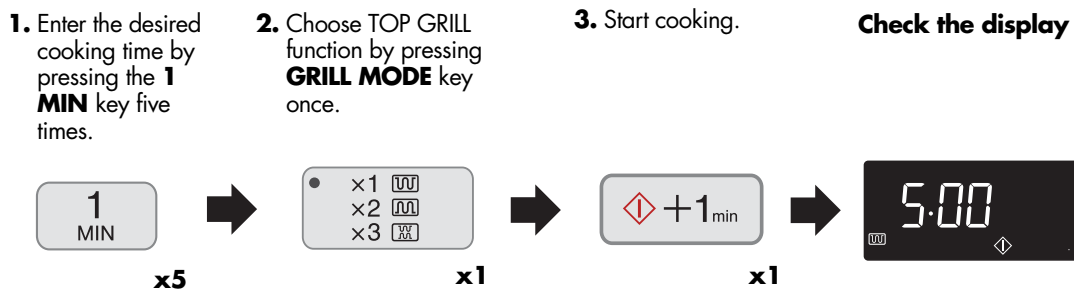

NOTES:

- 1.** The high or low racks are recommended when grilling.
- 2.** You may detect smoke or a burning smell when using the grill for the first time, this is normal and not a sign that the oven is out of order. Please see heating without food on the previous page.
- 3.** After cooking using TOP GRILL and BOTTOM GRILL the display may show 'NOW COOLING'.

WARNING: The oven cavity, door, outer cabinet, turntable, racks, dishes and especially the bottom grill will become very hot, always use thick oven gloves when removing the food or turntable from the oven to prevent burns.



CONVECTION COOKING

This microwave oven has 10 pre-set oven temperatures which use a combination of the top and bottom grills.

Press CONVECTION key	1	2	3	4	5	6	7	8	9	10
Oven Temperature (° C)	250	230	220	200	180	160	130	100	70	40

Note:

Temperature measurements taken whilst the oven is in convection mode will differ from the displayed level. This is due to the grill elements turning on and off in order to regulate the oven temperature. This will not affect the cooking results as long as the operation manual and cook book are followed correctly.

Example 1: To cook with preheating

Suppose you want to pre-heat to 180° C and cook for 20 minutes at 180° C.

- 1.** Enter the desired convection temperature by pressing the **CONVECTION** key five times. The display will show 180° C.

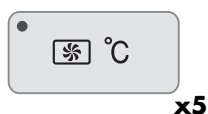

- 2.** Press the **START/+ 1 min** key to start pre-heating. The display shows "PREHEAT".



When the pre-heated temperature has been reached the audible signal sounds. The display will show "180C". Open the door and place the food inside the oven. Close the door.

- 3.** Enter the cooking time. Press the **10 MIN** key twice.



- 4.** Press the **START/+ 1 min** key.



Check the display

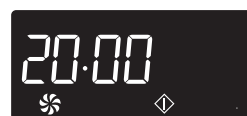

NOTES:

- After preheating, if you want to cook at a different temperature press the **CONVECTION** key until the desired setting appears on the display. In the example above, to change the temperature you would press the **CONVECTION** key after entering the cooking time.
- When the oven reaches the programmed temperature, it will automatically hold at the pre-heated temperature for 30 minutes. After 30 minutes the display will change to time of day, if set and the convection temperature will be cancelled.
- After cooking, the display may show "NOW COOLING".

WARNING: The oven cavity, door, outer cabinet, turntable, racks, dishes and especially the bottom grill will become very hot, always use thick oven gloves when removing the food or turntable from the oven to prevent burns.

CONVECTION COOKING



Example 2: To cook without preheating

Suppose you want to cook at 250°C for 20 minutes.

1. Enter the desired cooking time (20 min.) by pressing the **10 MIN** key twice.
2. Select the desired cooking temperature. (250°C).
3. Press the **START/+ 1 min** key.

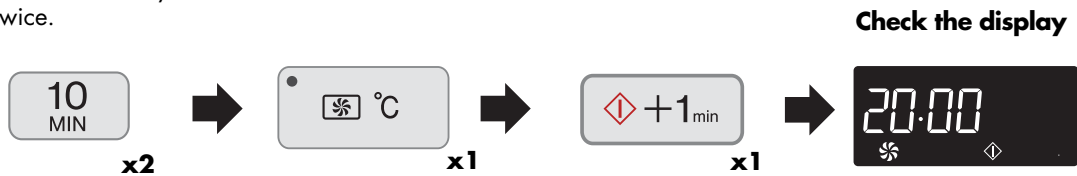

NOTES:

1. After cooking, the oven will automatically cool and the display may show "NOW COOLING".
2. To change the convection temperature, press the **CONVECTION** key until the desired temperature appears on the display.

WARNING: The oven cavity, door, outer cabinet, turntable, racks, dishes and especially the bottom grill will become very hot, always use thick oven gloves when removing the food or turntable from the oven to prevent burns.



DUAL COOKING

Your oven has 3 **DUAL** cooking modes combining the heat of the grill(s) with the power of the microwave. To select the **DUAL** cooking mode, press the **DUAL MODE** key until the desired setting appears in the display. Generally, dual cooking time shortens the total cooking time.

Press DUAL MODE key	Cooking method	Microwave Power Range	Symbol
DUAL 1 • x1 x2 x3 x1	MICRO 270 W CONV 250° C	90 W - 450 W	
DUAL 2 • x1 x2 x3 x2	MICRO 270 W TOP GRILL	90 W - 900 W	
DUAL 3 • x1 x2 x3 x3	MICRO 270 W BOTTOM GRILL	90 W - 900 W	

NOTES:

- To adjust the microwave power, press the **MICROWAVE POWER LEVEL** key.
- To adjust the convection temperature, press the **CONVECTION** key until the desired temperature appears on the display.
- For **DUAL 1** the oven temperature can be changed from 40° C to 250° C in ten levels.

Example 1:

Suppose you want to cook for 20 minutes using DUAL 1 (90 W microwave power and 200° C CONVECTION).

1. Enter the desired cooking time (20 min.) by pressing the **10 MIN** key twice.
2. Press the **DUAL MODE** key once.
3. Press the **MICROWAVE POWER LEVEL** key once (90 W).
4. Press **CONVECTION** key three times (200° C).

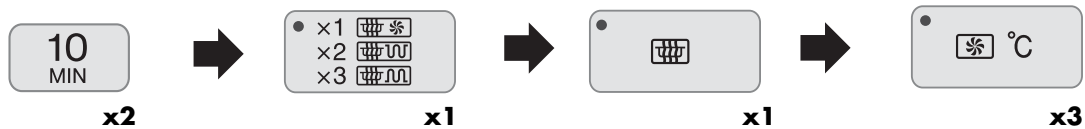

5. Start cooking.

Check the display



NOTE: After cooking, the display may show "NOW COOLING".

DUAL COOKING



Example 2:

Suppose you want to cook for 20 minutes on DUAL 2, using 90 W microwave power and TOP GRILL.

1. Enter the desired cooking time by pressing the **10 MIN** key twice.

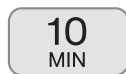

x2

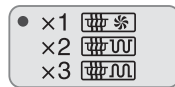

x2



x1



4. Start cooking.



x1

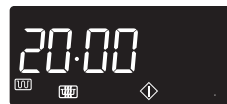

Check the display

NOTE: After cooking, the display may show "NOW COOLING".

WARNING: The oven cavity, door, outer cabinet, turntable, racks, dishes and especially the bottom grill will become very hot, always use thick oven gloves when removing the food or turntable from the oven to prevent burns.



OTHER CONVENIENT FUNCTIONS

1. MULTIPLE SEQUENCE COOKING.

A sequence of 4 stages (maximum) can be programmed which may combine the **MICROWAVE, GRILL, DUAL** or **CONVECTION** modes.

EXAMPLES OF SEQUENCE COOKING:

1. Micro or Preheat + Micro + Micro + Dual or Convection or Grill or Micro
2. Micro or Preheat + Dual or Convection or Grill or Micro + Dual or Convection or Grill or Micro
3. Dual or Convection or Grill or Micro + Micro + Dual or Convection or Grill or Micro

Example:

Stage 1: 10 minutes at 450 W power

Stage 2: 5 minutes Dual 2 at 90 W

Stage 3: 20 minutes using the TOP GRILL.

STAGE 1

1. Enter the desired cooking time (10 minutes) by pressing the **10 MIN** key once.
2. Select 450 W microwave power by pressing the **MICROWAVE POWER LEVEL** key three times.



x1



x3



STAGE 2

3. Enter the desired cooking time (5 minutes) by pressing the **1 MIN** key five times.
4. Select DUAL MODE 2 only, by pressing the **DUAL MODE** key twice.
5. Select 90 W low power by pressing the **MICROWAVE POWER LEVEL** key once.



x5

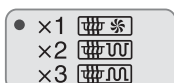

x2



x1



STAGE 3

6. Enter the desired cooking time (20 minutes) by pressing the **10 MIN** key twice.
 7. Select TOP GRILL by pressing the **GRILL MODE** key once.
 8. Start to cook by pressing the **START/+1 min** key.
- Check the display**



x2

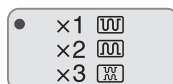

x1



x1



OTHER CONVENIENT FUNCTIONS



2. LESS / MORE keys.

The **LESS** (▼) and **MORE** (▲) keys allow you to easily decrease or increase programmed setting times, (for a less well or more well cooked result), used for **AUTOMATIC** operations or when cooking is underway.

a) Changing the pre-programmed time setting.

Example:

Suppose you want to cook 0,9 kg Roast chicken using the **AUTOMATIC** and **MORE** (▲) keys.

1. Choose the **AUTOMATIC** menu for Roast chicken by pressing the **AUTOMATIC** key once.

2. Choose the desired result (well cooked) by pressing the **MORE** key once within 2 seconds.

3. The oven will start to cook automatically.



x1



x1



NOTES:

To cancel **LESS** or **MORE** press the same key again.

To change **MORE** to **LESS** simply press the **LESS** (▼) key.

To change **LESS** to **MORE** simply press the **MORE** (▲) key.

b) Changing the heating time while the oven is operating:-

The cooking time can be decreased or increased in 1 minute steps each time the **LESS** (▼) and **MORE** (▲) keys are pressed.

3. +1 min function

The **+1 min** function allows you to operate the following functions:

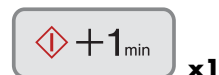

a) Direct Start

You can start to cook directly on full microwave power (900 W) and in 1 minute steps by pressing the **START/+1 min** key.

NOTE: To avoid children's misuse, the **START/+1 min** key can be used only within 2 minutes after a preceding operation, i.e., closing the door or pressing the **STOP** key.

b) Extending the cooking time.

You can extend the cooking time in multiples of 1 minute, by pressing the **START/+1 min** key, during the cooking process.



OTHER CONVENIENT FUNCTIONS

4. TO CHECK SETTINGS WHILE THE OVEN IS OPERATING

You can check the power level, oven temperature, the programmed and actual oven temperatures ie: when pre-heating.

TO CHECK THE POWER LEVEL:

To check the microwave power level during cooking press the **MICROWAVE POWER LEVEL** key. The oven continues to count down, although the display shows the power level.

As long as your finger is pressing the key, the power level will be displayed.



TO CHECK THE CONVECTION TEMPERATURE:

To check the convection temperature during cooking press the **CONVECTION** key. When the oven is preheating, you can check the actual oven temperature.

As long as your finger is pressing the key, the convection temperature in °C will be displayed.

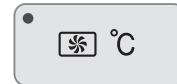

TO CHECK THE TIME OF DAY:

Firstly, the clock must already be set, see page 9. To check the time of day during cooking, press the **CLOCK SETTING** key.

As long as your finger is pressing the key, the time of day will be displayed.



AUTOMATIC OPERATION



The **AUTOMATIC** keys automatically work out the correct cooking mode and cooking time of the foods illustrated below.

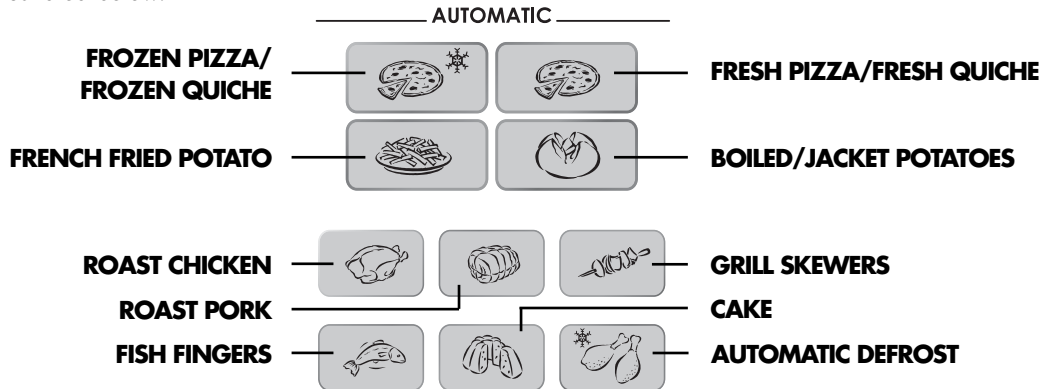

What you need to know when using the **AUTOMATIC** keys:

1. Input the menu by pressing the desired key. The **AUTOMATIC** keys can only be input within 2 minutes after cooking completion, closing the door or pressing the **STOP** key.
2. To increase the weight press the selected key until the desired weight is displayed. Enter the weight of the food only. Do not include the weight of the container.
For food weighing more or less than the weights/quantities given in the cooking charts (see separate cookery book) cook using manual operation.
3. The programmed cooking times are average times. If you want to alter the cooking times of **AUTOMATIC** programmes, use the **LESS** (▼) or **MORE** (▲) keys.
For best results use the cooking chart instructions (see separate cookery book).
4. The oven will start to cook instantly after the weight has been input.

WARNING: The oven cavity, door, outer cabinet, turntable, racks, dishes and especially the bottom grill will become very hot, always use thick oven gloves when removing the food or turntable from the oven to prevent burns.

NOTE:

When manipulation is required (eg: to turn food over) the oven will stop and the audible signal will sound, the display will show the necessary action. To continue cooking, press the **START/+ 1 min** key. The final temperature of the food will vary according to its initial temperature. Check food is piping hot after cooking. If necessary, you can extend the cooking time. Always refer to the cooking charts given in the separate cookery book.

Example: Suppose you want to cook 200 g of French Fried Potatoes.





Choose the menu and quantity by pressing the **FRENCH FRIED POTATO** key once.

The oven will instantly begin to cook.









AUTOMATIC COOKING CHART

KEY	MENU	WEIGHT (Increasing Unit) / UTENSILS	PROCEDURE
	Frozen Pizza/ Frozen Quiche	0,15 - 0,60 kg (50 g) for Pizza 0,15 - 0,40 kg (50 g) for Quiche (Initial temp. -18° C) Directly on the turntable	<ul style="list-style-type: none"> Remove the ready prepared frozen pizza/quiche from the packaging. Place directly on the turntable. For thick base pizzas and ready prepared frozen quiches, press the MORE (▲) key before pressing the FROZEN PIZZA/FROZEN QUICHE key. After cooking, place on a plate for serving. For thick base pizza and quiche, let stand for 2 minutes.
	Fresh Pizza/ Fresh Quiche	0,7 - 1,0 kg (100 g) for Pizza 0,7 kg for Quiche (Initial temp. 20° C) Directly on the turntable	<ul style="list-style-type: none"> Prepare the pizza/quiche following the recipes on page 21. Place directly on the turntable. For quiche, press the MORE (▲) key before pressing the FRESH PIZZA/FRESH QUICHE key. After cooking, place on a plate for serving.
	French fried Potatoes (recommended for conventional ovens) e.g. French fried potatoes, potato croquettes	0,20 - 0,40 kg (50 g) (Initial temp. -18° C) Directly on the turntable	<ul style="list-style-type: none"> Remove the frozen, French-fried potatoes from the package and place them in one layer on the turntable. For thick French fried potatoes, use the MORE (▲) key, for potato croquettes use the LESS (▼) key. After cooking, remove from the turntable and put on a plate for serving.
	Boiled potatoes/ Jacket potatoes	0,1 - 0,8 kg (100 g) (Initial temp. 20° C) Bowl & lid	<p>Boiled Potatoes: Peel the potatoes and cut them into similar sized pieces. Jacket Potatoes: Choose potatoes of similar size and wash them.</p> <ul style="list-style-type: none"> Put the boiled or jacket potatoes into a bowl. Add the required amount of water (per 100g approx 2 tbsp) and a little salt. Cover with a lid. When the audible signals sound, stir and re-cover. After cooking, let the potatoes stand covered for 1-2 minutes.
	Roast Chicken	0,9 - 1,8 kg (100 g) (Initial temp. 5° C) Low rack	<ul style="list-style-type: none"> Mix the ingredients and spread on the chicken. Pierce the skin of the chicken. Put chicken breast side down on the low rack. When the audible signals sound, turn the chicken over. After cooking, leave for approx. 3 minutes in the oven, remove and put on a plate for serving.
	Ingredients for 1,0 kg roast chicken: 1/2 tsp Salt and Pepper, 1 tsp sweet paprika, 2 tbsp oil		

AUTOMATIC COOKING CHART



KEY	MENU	WEIGHT (Increasing Unit) / UTENSILS	PROCEDURE
	Roast Pork Ingredients for 1,0 kg rolled lean pork: 1 garlic clove crushed, 2 tbsp oil, 1 tsp sweet paprika, a little cumin powder, 1 tsp salt	0,6 - 2,0 kg (100 g) (Initial temp. 5° C) Low rack	<ul style="list-style-type: none"> Lean roast pork is recommended. Mix all ingredients and spread them onto the pork. Place the pork on the low rack. When the audible signals sound, turn over. After cooking, let the food stand wrapped in aluminium foil for approx. 10 minutes.
	Grill skewers See recipes on page XX of the Cookery book	0,2 - 0,8 kg (100 g) (Initial temp. 5° C) High rack	<ul style="list-style-type: none"> Prepare the grill skewers. Place on the high rack and cook. When the audible signals sound, turn over. After cooking, remove and put on a plate for serving. (No standing time necessary).
	Fish Fingers, Poultry meat pieces (e.g. chicken nuggets)	0,2 - 0,5 kg (100 g) (Initial temp. -18° C) Directly on the turntable	<ul style="list-style-type: none"> Grease the turntable lightly. Remove deep frozen fish fingers/chicken nuggets from the packaging and place them on the turntable. After cooking, place on a plate for serving. (No standing time is necessary).
	Cake See recipes on pages XX - XX of the Cookery book	0,5 - 1,5 kg (100 g) (Initial temp. 20° C) Cake dish	<ul style="list-style-type: none"> Prepare the cake. Place the cake dish directly on the turntable. Let the cakes stand for approximately 10 minutes after baking. <p>HINT: You can use ordinary black metal cake tins. If arcing occurs, put a saucer between the turntable and tins.</p>

PIZZA RECIPE

Ingredients:

- 300 g approx. Ready prepared dough (Ready mix or roll out dough)
- 200 g approx. Tinned tomatoes
- 150 g Topping as desired (eg. corn, ham, salami, pineapple)
- 50 g Grated cheese
- Basil, oregano, thyme, salt, pepper

Procedure:

- Prepare the dough according to the manufacturer's instructions. Roll out to the size of the turntable.
- Lightly grease the turntable and place the pizza base on it and pierce the dough.
- Drain the tomatoes and cut them into pieces. Season the tomatoes with the spices and spread on the dough. Put all other ingredients on the pizza and finally cover with the cheese.
- Cook the pizza using the **FRESH PIZZA/FRESH QUICHE** key.

QUICHE RECIPE

Ingredients:



- 200 g Puff pastry (frozen or chilled)
- 3 Eggs (size medium)
- 200 g Cream or milk
- 100 g Grated cheese (Emmenthal)
- 50 g Ham

Procedure:

- Defrost the pastry and roll it out to the size of the turntable. Place on the turntable and pierce the dough.
- Mix the eggs with the cream and the cheese together. Season with salt and pepper, and pour over the pastry.
- Sprinkle the ham over and cook the quiche using the **FRESH PIZZA/FRESH QUICHE** key and the **MORE (▲)** key.



AUTOMATIC DEFROST CHART

KEY	MENU	WEIGHT (Increasing Unit) / UTENSILS	PROCEDURE
	Automatic Defrost: Poultry	0,9 - 2,0 kg (100 g) (Initial temp. -18° C) (See note below)	<ul style="list-style-type: none"> Place a plate upside down on the turntable and put the poultry breast side down on the plate. When the oven stops and the audible signal sounds, turnover and shield the thin parts and warm spots with aluminium foil. After defrosting, cover with aluminium foil and stand for 30 - 90 minutes until thoroughly defrosted. Finally clean the poultry under running water.
	Automatic Defrost: Chicken Legs	0,2 - 1,0 kg (100 g) (Initial temp. -18° C) (See note below)	<ul style="list-style-type: none"> Place the food on a plate in the centre of the turntable. When the oven stops and the audible signals sound, turn the food over, rearrange and separate. Shield the thin parts and warm spots with aluminium foil. After defrosting, wrap in aluminium foil for 10 - 30 minutes, until thoroughly defrosted.
	Automatic Defrost: Steaks, Chops, Fish Fillets	0,2 - 1,0 kg (100 g) (Initial temp. -18° C) (See note below)	<ul style="list-style-type: none"> Place the food in a single layer on a plate in the centre of the turntable. If portions are frozen together, try to separate before defrosting. When the oven stops and the audible signals sound, turn the food over, rearrange and separate. Shield the thin parts and warm spots with aluminium foil. After defrosting, wrap in aluminium foil for 10 - 30 minutes, until thoroughly defrosted.

NOTE:

- Steaks, Chops, Fish fillets and Chicken legs should be frozen in one layer.
- For shielding the defrosted parts, use small, flat pieces of aluminium foil.
- The poultry should be cooked immediately after defrosting.
- Arrange the food in the oven as shown below:

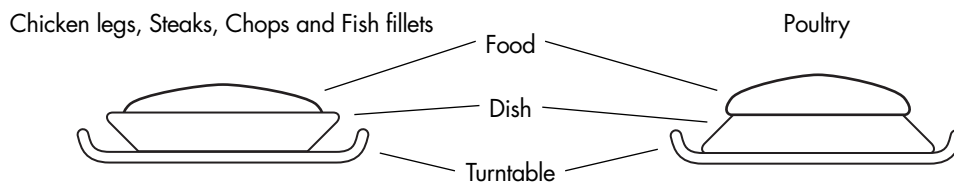

CARE AND CLEANING



CAUTION: DO NOT USE COMMERCIAL OVEN CLEANERS, STEAM CLEANERS, ABRASIVE, HARSH CLEANERS, ANY THAT CONTAIN SODIUM HYDROXIDE OR SCOURING PADS ON ANY PART OF YOUR MICROWAVE OVEN.

CLEAN THE OVEN AT REGULAR INTERVALS AND REMOVE ANY FOOD DEPOSITS. Failure to maintain the oven in a clean condition could lead to a deterioration of the surface that could adversely affect the life of the appliance and possibly result in a hazardous situation.

WARNING!

After **GRILL, DUAL, CONVECTION** and **AUTOMATIC** (except Automatic Defrost) modes, the oven cavity, door, oven cabinet and accessories will become very hot. Before cleaning, make sure they have cooled down.

Oven exterior

The outside of your oven can be cleaned easily with mild soap and water. Make sure the soap is wiped off with a moist cloth, and dry the exterior with a soft towel.

Oven controls

Open the door before cleaning to de-activate the oven controls. Care should be taken when cleaning the oven control. Using a moist cloth dampened with water only, gently wipe the panel until it becomes clean. Avoid using excessive amounts of water. Do not use any sort of chemical or abrasive cleaner.

Oven Interior

1. For cleaning, wipe any splatters or spills with a soft damp cloth or sponge after each use while the oven is still warm. For heavier spills, use a mild soap and wipe several times with a damp cloth until all residues are removed.
Do not remove the waveguide cover.
2. Make sure that mild soap or water does not penetrate the small vents in the walls which may cause damage to the oven.
3. Do not use spray type cleaners on the oven interior.
4. Heat up your oven regularly by using both heating elements, refer to "Heating without food" on page 10. Remaining food or fat splashed can cause smoke or bad smell.

Turntable

Remove the turntable from the oven. Wash the turntable in mild soapy water. Dry with a soft cloth. The turntable is dishwasher safe.

Low Rack and High Rack

These should be washed in a mild washing up liquid solution and dried. High and Low racks are dishwasher safe.

Door

To remove all trace of dirt, regularly clean both sides of the door, the door seals and sealing surfaces with a soft, damp cloth.

NOTE: A steam cleaner should not be used.



SERVICE CALL CHECK

PLEASE CHECK THE FOLLOWING BEFORE CALLING FOR SERVICE:

1. Power Supply:

Check the power plug is properly connected to a suitable wall outlet.

Check the line fuse/circuit breaker is functioning properly.

2. When the door is opened, does the oven lamp light? YES _____ NO _____

3. Place a cup of water (approx. 150 ml) in the oven and close the door securely.

Set the cooking mode to microwave cooking mode.

Programme the oven for one minute on full power (900 W) and start the oven.

Does the oven lamp light? YES _____ NO _____

Does the turntable rotate? YES _____ NO _____

NOTE: The turntable turns in either direction.

Does the ventilation work? YES _____ NO _____

(Place your hand over the ventilation openings and check for air flow.)

After 1 minute does the signal sound? YES _____ NO _____

Does the cooking in progress indicator go off? YES _____ NO _____

Is the cup of water warm after the above operation? YES _____ NO _____

4. Set the GRILL cooking mode using the top grill and bottom grill for 3 minutes.





After 3 minutes do both GRILL heating elements become red? YES _____ NO _____

If you answer "NO" to any of the above questions, call a Service Technician appointed by SHARP and report the results of your check. See inside back cover for details of address.

IMPORTANT: If the display shows nothing even if the power plug is properly connected, the energy save mode should carry on. To release it, open and then close the oven door. See page 8.

NOTES:

1. If you cook the food over the standard time with only the same cooking mode, the power of the oven will lower automatically to avoid overheating. (The microwave power level will be reduced and the grill heating elements will begin to light on and off.)

Cooking mode	Standard time
Microwave 100 % cooking	20 min.
Grill cooking	
TOP GRILL 	30 min.
BOTTOM GRILL 	45 min.
TOP and BOTTOM GRILL 	Top grill - 15 min. Bottom grill - 15 min.
Dual 2 	Micro - 20 min. Top grill - 15 min.
Dual 3 	Micro - 20 min. Bottom grill - 15 min.

2. After the **GRILL** (using both heating elements), **DUAL**, **CONVECTION** and **AUTOMATIC** (except Automatic Defrost), the cooling fan will run until the oven has cooled down. Also, when you press the **STOP** key and open the door during the **GRILL**, **DUAL**, **CONVECTION** and **AUTOMATIC** (except Automatic Defrost), the cooling fan will run; you may, therefore, feel air blowing from the ventilation openings.

- SEULEMENT VALIDE POUR L'ALLEMAGNE ET L'AUTRICHE • SLECHTS GELDIG VOOR DUITSLAND EN OOSTENRIJK •
• SOLTANTO VALIDO PER LA GERMANIA E L'AUSTRIA • SOLAMENTE VÁLIDO PARA ALEMANIA Y AUSTRIA •

Vorgehensweise bei Vorliegen eines Produktmangels:

- Wurde Ihr Gerät durch einen Fachbetrieb mit einem von Sharp genehmigten Einbaurahmen oder rahmenlos ein-/ untergebaut, können Sie die unter Ziffer 1. aufgeführten Garantieansprüche im Rahmen des Quick 48 Stunden Vor-Ort-Service geltend machen und sich direkt an den KUNDEN-SERVICE wenden oder Sachmängel gegenüber Ihrem Verkäufer geltend machen.
- Für alle übrigen Geräte können Sie die unter Ziffer 2. aufgeführten Garantieansprüche ohne Quick 48 Stunden Vor-Ort-Service oder Sachmängel gegenüber Ihrem Verkäufer geltend machen.

DER SHARP KUNDEN-SERVICE



Hotline - Deutschland: **0180 - 523 46 74** (€ 0,12/Min.)
Hotline - Österreich: **0820 - 240 496** (€ 0,145/Min.)

Sie erreichen die Service-Hotline:
montags bis freitags zwischen 9 und 17 Uhr
in Deutschland: 0180 - 523 46 74 (€ 0,12/Min.)
in Österreich: 0820 - 240 496 (€ 0,145/Min.)

1. Garantie mit Quick 48 Stunden Vor-Ort-Service

Gilt für Deutschland und Österreich

Haushalts- Mikrowellengeräte im Quick 48 Stunden Vor-Ort-Service

Sehr geehrter Sharp Kunde,

alle ein-/ untergebauten Haushalts-Mikrowellengeräte, die durch einen Fachbetrieb fachgerecht mit einem von SHARP genehmigten Einbaurahmen oder rahmenlos ein-/ bzw. untergebaut worden sind, werden im Quick 48 Vor-Ort-Service abgewickelt. Die in dieser Garantie beschriebenen Ansprüche stehen Ihnen zusätzlich neben den gesetzlichen Sachmängelansprüchen gegen Ihren Verkäufer zu.

Umfang der Garantie: Sollte Ihr Mikrowellengerät trotz sorgfältiger Herstellung und Endkontrolle einen Mangel aufweisen, können Sie innerhalb der Garantiezeit, Garantieleistungen gegen Sharp Electronics (Europe) GmbH in Anspruch nehmen. Diese stehen Ihnen zu, wenn ein herstellungsbedingter Material- und/oder Verarbeitungsmangel (nachfolgend „Mangel“) bei dem Mikrowellengerät oder Teilen davon - mit Ausnahme der Garraum-Glühlampe - innerhalb von 24 Monaten auftritt. Die Garantie umfasst nicht Mängel, die durch unsachgemäße Behandlung, Bedienungsfehler oder durch Fremdeinwirkung entstanden sind. Transportschäden bei Neugeräten müssen Sie bei Ihrem Verkäufer geltend machen. Die Garantiefrist von 24 Monaten beginnt mit dem Tag, an dem Sie das fabrikneue Gerät von einem Händler gekauft haben. Die Erbringung von Garantieleistungen verlängert nicht die Garantiezeit.

**Die Garantie gilt für alle Geräte, die in Deutschland ab dem 01.12.2001
und in Österreich ab dem 01.04.2004 gekauft worden sind.**

Garantieleistungen: Sharp Electronics (Europe) GmbH erfüllt seine Garantiepflichtungen für Mängel durch kostenlose Reparatur und einen **Quick 48 Stunden Vor-Ort-Service**. Etwa anfallende Transportkosten innerhalb Deutschlands und Österreich übernehmen wir.

Im Quick 48 Stunden Vor-Ort-Service werden alle Reklamationen, die an Werktagen außer samstags bis 17:00 Uhr beim Quick 48 Deutschland, Tel.: 0180 / 5 23 46 74 *(€ 0,12/Min) und in Österreich Tel.: 0820 / 240 496 *(€ 0,145/Min) eingehen, ab dem darauffolgenden Werktag gerechnet, im Regelfall innerhalb 48 Stunden bei Ihnen im Vor-Ort-Service repariert.

Geltendmachung der Garantie: Der Mangel des Gerätes muss innerhalb der Garantiefrist unter Angabe des Kaufdatums, der Modellbezeichnung und der Seriennummer des Gerätes unter den oben aufgeführten Telefonnummern Deutschland Tel.: 0180 / 5 23 46 74 (€ 0,12/Min) und Österreich Tel.: 0820 / 240 496 (€ 0,145/Min) geltend gemacht werden. Bei der Vor-Ort-Reparatur ist dann der Kaufbeleg, aus dem sich das Kaufdatum, die Modellbezeichnung und die Seriennummer des Gerätes ergibt, vorzulegen.

Achtung:

Wird dieser Service für von Ihnen selbst ein-/untergebaute Geräte in Anspruch genommen, sind für Aus-/und Einbau, Fahrzeit und Km die entstehenden Kosten von Ihnen zu tragen!

Bitte erkundigen Sie sich vor Anforderung des Kundendienstes bei diesem über die anfallenden Kosten. Den für Sie nächstgelegenen Kundendienst nennt Ihnen gern unsere o.g. Hotline.

Als Nachweis für Sachmängel-/ Garantiarbeiten dient Ihr Kaufbeleg / Rechnung.

Selbstverständlich können Sie unseren QUICK 48 Vor-Ort-Service Mikrowellengeräte auch nach Ablauf der Verjährungsfristen für Sachmängel-/Garantiefristen in Anspruch nehmen, dann jedoch gegen Aufwandsberechnung des jeweiligen Kundendienstes.

**Garantiegeber: SHARP Electronics (Europe) GmbH, Sonninstraße 3, 20097 Hamburg
www.sharp.de**

• SEULEMENT VALIDE POUR L'ALLEMAGNE ET L'AUTRICHE • SLECHTS GELDIG VOOR DUITSLAND EN OOSTENRIJK •
• SOLTANTO VALIDO PER LA GERMANIA E L'AUSTRIA • SOLAMENTE VÁLIDO PARA ALEMANIA Y AUSTRIA •

Vorgehensweise bei Vorliegen eines Produktmangels:

- Wurde Ihr Gerät durch einen Fachbetrieb mit einem von Sharp genehmigten Einbaurahmen oder rahmenlos ein-/ untergebaut, können Sie die unter Ziffer 1. aufgeführten Garantieansprüche im Rahmen des Quick 48 Stunden Vor-Ort-Service geltend machen und sich direkt an den KUNDEN-SERVICE wenden oder Sachmängel gegenüber Ihrem Verkäufer geltend machen.
- Für alle übrigen Geräte können Sie die unter Ziffer 2. aufgeführten Garantieansprüche ohne Quick 48 Stunden Vor-Ort-Service oder Sachmängel gegenüber Ihrem Verkäufer geltend machen.

2. Garantie ohne Quick 48 Stunden Vor-Ort-Service

Gilt für Deutschland und Österreich

Haushalts - Mikrowellengeräte

Wichtiger Endkunden – Hinweis: Serviceabwicklung nur über den Verkäufer. Die in dieser Garantie beschriebenen Ansprüche stehen Ihnen zusätzlich neben den gesetzlichen Sachmängelansprüchen gegen Ihren Verkäufer zu.

Sehr geehrter Sharp Kunde,

SHARP- Geräte sind Markenartikel, die mit Präzision und Sorgfalt nach modernen Fertigungsmethoden hergestellt werden. Bei sachgemäßer Handhabung und unter Beachtung der Bedienungsanleitung wird Ihnen Ihr Gerät lange Zeit gute Dienste leisten.

Das Auftreten von Fehlern ist aber nie auszuschließen. Sollte Ihr Gerät innerhalb der gesetzlichen oder mit Ihrem Verkäufer vereinbarten Verjährungsfristen für Sachmängel-/ Garantiefristen einen Mangel aufweisen und das Gerät wurde **nicht von Ihrem Handelspartner ein-/unter-gebaut**, so wenden Sie sich bitte an den Verkäufer, bei dem Sie das Gerät erworben haben und geben Sie das defekte Gerät dort ab, denn dieser ist Ihr Ansprechpartner für Sachmängel.

Umfang der Garantie: Wenn ein herstellungsbedingter Material- und/oder Verarbeitungsmangel (nachfolgend „Mangel“) bei dem Gerät oder Teilen davon - mit Ausnahme der in der Bedienungsanleitung angegebenen Teile mit begrenzter Lebensdauer – innerhalb von 24 Monaten auftritt, können Sie unsere Garantieleistung in Anspruch nehmen.

Die Garantie umfasst nicht Mängel, die durch unsachgemäße Behandlung, Bedienungsfehler oder durch Fremdeinwirkung entstanden sind.

Die Garantiefrist von 24 Monaten beginnt mit dem Tag, an dem Sie das fabrikneue Gerät von einem Händler gekauft haben. Die Erbringung von Garantieleistungen verlängert nicht die Garantiezeit.

Die Garantie gilt für alle Geräte, die ab dem 01.12.2001 in Deutschland und in Österreich ab dem 01.04.2004 gekauft worden sind.

Garantieleistung: Sharp Electronics (Europe) GmbH erfüllt seine Garantieverpflichtung für Mängel nach seiner Wahl durch kostenlose Reparatur oder durch Austausch des mangelhaften Gerätes gegen ein mangelfreies. Etwa anfallende Transportkosten innerhalb Deutschlands und Österreich werden von uns übernommen.

Geltendmachung der Garantie: Um die Garantie in Anspruch nehmen zu können, benötigen Sie den Kaufbeleg (Rechnung, Quittung) aus dem sich das Kaufdatum, die Modellbezeichnung und Seriennummer des Gerätes ergibt. Der Mangel des Gerätes muss innerhalb der Garantiefrist von Ihnen gegenüber einem Sharp Service-Partner oder einem autorisierten Händler von Sharp Electronics (Europe) GmbH geltend gemacht werden. Bei weiteren Fragen wenden Sie sich bitte an unsere **Service-Hotline 01805-29 95 29 *** (€ 0,12 /Min)

Selbstverständlich können Sie die Hilfe unserer Service-Hotline 01805-29 95 29 * (€ 0,12 /Min) für

Sharp-Mikrowellengeräte auch nach Ablauf der Verjährungsfristen für Sachmängel-/Garantiefristen in Anspruch nehmen, dann jedoch gegen Aufwandsberechnung des jeweiligen Kundendienstes.

**Garantiegeber: SHARP Electronics (Europe) GmbH, Sonninstraße 3, 20097 Hamburg
www.sharp.de**

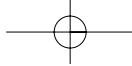

• ADDRESSES D'ENTRETIEN • ONDERHOUDSADRESSEN • DIRECCIONES DE SERVICIO • INDIRIZZI DI SERVIZIO •

BELGIUM - <http://www.sharp.be>

En cas d'une réclamation concernant une four a micro-onde SHARP, nous vous prions de vous adresser à votre spécialiste ou à une adresse des SHARP Services suivantes.

Indien uw magnetron problemen geeft kunt u zich wenden tot uw dealer of een van de onderstaande Sharp service centra.

SHARP ELECTRONICS, Phone: 0900-10158

AVTC, Kleine Winkellaan 54, 1853 Strombeek-Bever, 02/2674019 / **ETS HENROTTE**, Rue Du Campinaire 154, 6240 Farciennes, 071/396290 / **Nouvelle Central Radio (N.C.R.)**, Rue des Joncs 15 L-1818 HOWALD, 00352404078 / **Service Center Deinze**, Kapellestraat, 95, 9800 DEINZE, 09-386.76.67

NEDERLAND - <http://www.sharp.nl>

Indien uw magnetron problemen geeft kunt u zich wenden tot uw dealer of naar onderstaand Sharp Service Centrum.

SHARP ELECTRONICS BENELUX BV, - Helpdesk -, Postbus 900, 3990 DW Houten, 0900-7427723

FRANCE - <http://www.sharp.fr>

En cas de réclamation pour les fours micro-ondes SHARP, nous vous prions de vous adresser à votre spécialiste ou à l'une des stations techniques agréées SHARP suivantes:

A.A.V.I., 1 rue du Mont de Terre, 59818 Lesquin Cedex, 03.20.62.18.98 / **A.A.V.I. (Point d'Accueil)**, 9-11 rue Léon Trulin, 59000 Lille, 03.20.14.96.20 / **ATELIER ROUSSEL**, 12 Bld Flandre Dunkerque, 56100 Lorient, 02.97.83.07.41 / **BASTIA TELE VIDEO**, Immeuble Le Béarn - Av. de la libération, 20600 Bastia, 04.95.30.81.29 / **C.M.T.S.**, 38 rue des Ormeaux, 75020 Paris, 01.43.70.20.00 / **ELECTRONIC SERVICE PLUS**, 5 bd LOUIS XI - ZI le Meneton, 37000 Tours, 02.47.77.90.90 / **ELECTRO SERVICE**, 21 rue de Mulhouse - B.P 122, 68313 Illzach, 03.89.62.50.00 / **M.R.T.**, 74 Rue Albert Einstein - 72021 Le Mans Cedex, 02.43.28.52.20 / **S.T.E.**, 3 chemin de l'Industrie, 06110 Le Cannet Rocheville, 04.93.46.05.00 / **S.T.R. AQUITAINE**, 111 rue Bouthier - B.P 27, 33015 Bordeaux, 05.57.80.78.07 / **S.T.V.S.**, 1 rue de la Presse, 42000 Saint Etienne, 0825.898.903 / **S.T.V.S.**, 10 chemin Saint Gobin, 69 190 Saint fons, 04.72.89.06.89 / **S.T.V.S. (point d'accueil)**, 143 av Maréchal de Saxe, Entrée: 54 rue Villeroy, 69003 Lyon 04.78.62.07.05 / **TECH SERVICE**, 15 rue du château de ribaute, ZA ribaute 2, 31130 Quint Fonsegrives, 05.62.57.63.90 / **TIMO VIDEO**, 131 chemin des bassins, Zone Europarc - Hameau D, 94000 Creteil, 01.43.39.08.18 / **U.N.T.D.**, 1 rue des Lourdines, 76000 Rouen, 02.35.72.28.04

ITALIA - <http://www.sharp.it>

Nel caso si verificassero problemi alla vostra apparecchiatura potrete rivolgervi presso un nostro centro di assistenza autorizzato sharp

ABRUZZO: CTR di de Berardinis vincenzo, Via Giuseppe Cacchi L'Aquila, 0862-315407 / **CTR di de Berardinis vincenzo**, Via P. Gobetti Avezzano L'Aquila, 0863-412131 / **Marinangeli Fabrizio**, Via Rocco Carabba L'Aquila, 0862-310279 / **Marinangeli Fabrizio**, Via F.lli Rosselli Avezzano L'Aquila, 0863-25207 / **Elettrovideo snc**, Via Tiburtina Pescara, 085-52020 / **Cat di Bellone**, Via Dell' Aereoporto Teramo, 0861-415745

BASILICATA: SUONO E IMMAGINE di Conti Massimo, Via E. Maiorana Matera, 0835-389310

CALABRIA: Battaglia Saverio, Via C. Colombo Catanzaro Lido, 0961-33824 / **S.A.T.E. di Dodaro**, Via degli Stadi Cosenza, 0984-482337 / **SE.RI.EL.CO.**, Via delle Medaglie d'Oro Cosenza, 0984-33152 / **Eurotrading dei F.lli Aiello G. & D. snc**, Via Torino Crotone, 0962-20889 / **Assistenza Tecnica Cozzupoli & Crupi snc**, Via R. Campi primo tronco 103 Reggio Calabria, 0965-24022 / **Ater snc**, Via Naz. Pentimela 159/a-b Reggio Calabria, 096547051 / **Ciano Giuseppe**, Via Seconda Traversa Toscanini Taurianova, 0966-643483 / **Audio Video snc**, Via A. De Gasperi 4/e Vibo Valentia, 0963-45571 o 45572

CAMPANIA: Elettronica D' Argenio, Via Nazionale Torrette Nercogliano Avellino, 0825-681590 / **D.R.F. di Rubbo**, Via L. Piccinato Benevento, 0824-62416 / **Audio Service**, Via Cattaneo 4/6 Caserta, 0823-329099 / **Congestri' Ignazio**, Via Giordano Bruno Maddaloni Caserta, 0823-437704 / **Elettronica Service snc di Starace Aniello e C.**, Viale Europa Castellamare di Stabia Napoli, 081-8728280 / **Erredesse Service**, Via P. Mascagni Napoli, 081-5794825 / **SATEP**, Via Nazionale delle Puglie 176 Casoria Napoli, 081-7590706 / **Video Elettronica 2 di Nasti**, Via Antonino Pio Napoli, 081-7676300 / **M.C. Elettronica snc di Milito M. e Della Sala**, Via dei Mille Salerno, 089-330591 / **Netti Gianfranco**, Via Magna Grecia Capaccio Scalo Salerno, 0828-730071

EMILIA ROMAGNA: MA.PI. snc, Via T. Azzolini Bologna, 051-6414115 / **VIDEO 2000 SRL**, Via dell'Industria Bologna, 051-531581/624060 / **Assistenza Electron di Fogli**, Via F.lli Aventi Ferrara, 0532-903250 / **Stema snc**, Viale Bologna Forli, 0543-704475 / **Audio Video Center**, Via Vandelli 23 Modena, 059-235219 / **REAT srl**, Via Giardini Nord 8 Formigine Modena, 059-557168 / **Ecoservice Srl**, Via Buffolara 68A Parma, 0521-987402 / **Parmaservice sas**, Via Benedetta Parma, 0521-271666 / **Riparazioni Elettriche Ravenna**, Via Reale Camerlona Ravenna, 0544-521500 / **Technolab snc**, Via Romea Ravenna, 0544-64008 / **RTE RADIO TV ELETTRONICA di I. Catellani & C.**, Via Premuda Reggio Emilia, 0522-381277 / **Masini Service**, Via Mediterraneo Bellaria Rimini, 0541-347714 / **Novatecnica snc**, Via Giovanale Rimini, 0541-736361 / **Nuova Tecnocoop**, Via Armellini Bellariva di Rimini, 0541-370812

FRIULI VENEZIA GIULIA: D.R.M. di de Monte Ignio, P.ZA Montesanto S. Lorenzo Isonfino Gorizia, 0481-808858 / **AVR di Dri sas**, Via Colonna 20/8 Pordenone, 0434-27669 / **Officina Elettom. di Starace Elio**, Via Caprin Trieste, 040-773718

LAZIO: A.P. Rip. Arduini Piero, Via Licinio Refice 192 Frosinone, 0775-291267 / **Palmieri Francesco**, Via S. Polledrara Frosinone, 0775-291485 / **Elettronica 81**, Via Ezio Latina, 0773-694608 / **Italreg di Albano**, Parco Belvedere Conca 74 Gaeta, 0771-470851 / **CTS centro tecnico specializzato**, Via Rialto Roma, 06-39729748 / **Panaservice SRL**, Via Barbana 35 Roma, 06-5409766 / **Video Service sas di G. Calabrese & C. (VT)**, Str. Teverina Viterbo, 0761-251557

LIGURIA: G.A.T.E. snc, Passo P. Carrega Genova, 010-8361543 / **STAE SINC**, Corso A. Gastaldi Genova, 010-5299269 / **Cat snc di Ginulla O. & Rebuffo M.**, Via L. Giordano Imperia, 0183-710920 / **Michelis Sandro**, Via Giannetti Imperia, 0183-275891 / **RIEN snc**, Via Valle La Spezia, 0187-21925 / **Tognetti service**, Via Lunigiana La Spezia, 0187-507656 / **Teleservice snc**, Via Ponchelli 27R Savona, 019-810058

LOMBARDIA: Video Service snc, Via Locatelli Seriate Bergamo, 035-296883 / **Baccinelli Marzio & C. snc**, Via Branze Brescia, 030-2006411 / **Eurotecnica di Ronchi**, Via Milano Brescia, 030-317673 / **S.T.A.R.T. Video Hi-Fi**, Via Orii Romani Cremona, 0372-38731 / **Sae di Oneda M. snc**, Via Chinaglia Cremona, 0372-460314 / **Tecnovideo snc**, P.zza De Gasperi Mantova, 0376-321554 / **A.E. snc**, via Acerbi 28 Milano, 02-66220906 / **AT Electronics**, Piazza Cartagine 4 Milano, 02-58019146 / **Test TV snc**, Via Altamura Milano, 02-4035408 - 406441 / **Morini Daniele**, Via Maiocchi Voghera Pavia, 0383-368740 / **Crel snc**, Via Carducci Sondrio, 0342-216538 / **Elettronica Cappi**, Via Gorizia Sondrio, 0342-210459 / **Salvadori Claudio**, Via del Bosco Busto Arsizio Varese, 0331-329973 / **Salvadori Claudio Succursale**, Via Merano Varese, 0332-333501 / **Teletecnica 2000**, Via Torino Gallarate Varese, 0331-775519

MARCHE: Digitecnica di Moroni R: & c snc, Via Zuccarini Candia, 071-2866067 / **Marconi Lanfranco**, Via Monte Bianco Porto d'Ascoli, 0735-659230 / **Pluritecnica di Campitelli A. Nespeca M. snc**, Via Gradara Ascoli Piceno, 0736-342635 / **SAT Radio TV snc**, Via D. Rossi Macerata, 0733-231304 / **C.A.T. snc**, Via A. Cecchi Pesaro, 0721-25608 / **SAT 2000 snc di Sparamonti P. e C.**, Via dello Stadio. 16 Terni, 0744-424133

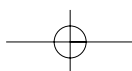

• ADDRESSES D'ENTRETIEN • ONDERHOUDSADRESSEN • DIRECCIONES DE SERVICIO • INDIRIZZI DI SERVIZIO •

PIEMONTE: **Siragusa & Roagna**, C.so Matteotti Asti, 0141-531131 / **Arte e Tecnica snc**, Via Falletti 22 Biella, 015-8496250 / **Alpilab di Giordano**, Corso Giovanni XXIII 11 Cuneo, 0171-690384 / **Videotext di Oberto Stefano**, P.za Trento e Trieste Canale Cuneo, 0173-95878 / **Guida di Guida Alessio**, Via Roggiolo Trecate Novara, 0321-71608 / **El.te di Antonello Adriano**, Via Ugo Foscolo Torino, 011-6503786 / **REAT di Frisina Rita**, Corso Unione Sovietica 584 Torino, 011-3979817 / **Elektro di Fiore Francesco**, Via Tripoli Vercelli, 0161-250071

PUGLIA: **Marinelli Benedetto**, Via dei Salici Barletta, 0883-514054 / **SAT sas di Partipilo**, Via Borsellino e Falcone 17 bis Bari, 080-5022999 / **Astrotec p.s.c.a.r.l.**, Viale Ofanto Foggia, 0881-685013 / **Stear snc**, Via E. Perrone Foggia, 0881-778483 / **Arnesano Faustino**, Via M. Moscardino 10 Lecce, 0832-318277 / **Microkey srl**, Via Giammatteo Lecce, 0832-399398 / **Microkey srl**, Via de Giuseppe Maglie Lecce, 0836-424813 / **Santoro Atilio**, Via Marche 24 Taranto, 099-335884

SARDEGNA: **AS.TEC. Elettronica**, Via Riva Villasanta 227 Cagliari, 070-524153 / **Floris Sergio**, Via Mazzini Gonnese, 0781-45436 / **G.S. Elettronica di Porcu Giuseppe M.**, Via della Resistenza Nuoro, 0784-203084 / **Co.ri.fr.el. 2**, Via del Castagno Settore "D" Olbia, 0789-562104 / **Videoelettronica snc**, Via Torino Sassari, 079-276616

SICILIA: **Service Russo di Russo Alfonso**, Via Dei Giovani Agrigento, 0922-610788 / **Video Service di De Francisci Paolo**, Via P.Nenni Agrigento, 0922-595881 / **Vullo Michele**, Via Gorizia Caltanissetta, 0934-551367 / **A.V.S. Elettronica**, Via Sassari 2/c Catania, 095-446696 / **Cuppari Electronics**, via S. Agostino 15 Messina, 090-672064 / **Cuppari Electronics Succursale**, Via Libertà Capo d'Orlando Messina, 0941-911785 / **Tecnica Sud snc**, Viale Regina Elena Messina, 090-40037 / **Alamia Service Piccola Cooperativa**, C.so Pisani 310/312 Palermo, 091-6570502 / **Di Fonzo F. & Figli snc**, Via Ruggero Loria Palermo, 091-363578 / **Elettronica di Di Tullio Maria**, Via Carlentini Siracusa, 0931-758602 / **Latino Impianti**, Via Eloro Rosolini Siracusa, 0931-857099 / **Tecnico Siracusana**, Via Novelli Siracusa, 0931-39440 / **Arte TV sas**, Via G. Centorbi 17 Mazara del Vallo Trapani, 0923-908160 / **Euroservice 2000**, via degli Atleti 61/c Marsala Trapani, 0923-956475

TOSCANA: **Bardazzi Paolo**, Via Forlanini 8DR Firenze, 055-4376776 / **Cate di Lepri Guido e C. snc**, Via Segantini Empoli, 0571-80652 / **Centi Franco**, Via Dosio 83 Firenze, 055-710388 / **Laboratorio Tv Arrighi**, Via F.lli Cervi P.A. Elsa Empoli, 0571-931327 / **M2 Elettronica**, Via Danimarca Grosseto, 0564-454571 / **NA.TO.MA. snc**, Via del sabotino 13 Grosseto, 0564-456229 / **Cate di Lepri Guido e C. snc**, C.so Matteotti Cecina, 0586-635071 / **A.T.E.S.**, Via Torino 3/a Livorno, 0586-859566 / **Laboratorio Riparazioni Falchi**, Via A. Garibaldi Piombino, 0565-49400 / **Teleservice di D'Amicis E. & V. snc**, Via P. Pisana Livorno, 0586-400564 / **E.T.S. di Napolitano Biagio**, Via Bientina Altopascio, 0583-269196 / **Elettronica RNP**, Via Romana Lucca, 0583-956225 o 957565 / **MGM Service snc di Martinelli**, Via Paolinelli Capannori, 0583-30382 / **DBS ELETTRONICA di Aldovardi S. & C. snc**, Via Simon musico Massa, 0585-489893 / **SAEC**, Via degli Artigiani Massa, 0585-251724 / **Belcari Enrico**, Via J. Gagarin Pisa, 0587-420273 / **E.T.S. di Napolitano Biagio**, Via Lucchese Montecatini Terme, 0572-767430 / **Cate di Lepri Guido e C. snc**, Via Fiorentina Prato, 0574-632652 / **Teleservice di Benvenuti Stefano**, Via E.Fermi 9/13 Prato, 0574-580840 / **PA.RI.EL.S.di Barletti Mirella**, Via B.Tolomei 9 Siena, 0577.51159

TRENTINO ALTO ADIGE: **Dal Pozzo Enzo**, Via Barletta Bolzano, 0471-913290 / **Tecnoservice snc**, Via San Vigilio Bolzano, 0471-289062 / **Melone Michele**, Via Zara Trento, 0461-235166 / **Sighel Mauro**, Via A. Volta Trento, 0461-935919

UMBRIA: **Baldassarri G. & G. snc**, Via A. Manna S. Andrea delle Fratte, 075-5270921 / **Tecnoconsult Elettronica**, Via Madonna Alta Perugia, 075-5003089 / **Quondam**, Via del Rivo Terni, 0744-301512

VALLE D'AOSTA: **Cat di D'Isanto**, C.so Ivrea Aosta, 0165-364056

VENETO: **D.D. Assistenza Tecnica snc**, Via Mondin Belluno, 0437-30240 / **Pierezza Carlo**, Via Barroccio dal Borgo Padova, 049-681592 / **L'Elettronica più snc**, Via Gaspare Campo Rovigo, 0425-33221 / **Assistenza Elettronica Campi**, Via E. Reginato Treviso, 0422-436245 / **Franchino gianfranco**, Via Zermanese 6B Treviso, 0422-321054 / **Video Tv1732**, Via San Marco Sottomarina, 041-5541675 / **Vignando Luigino**, Via dell' Industria Gruarò, 0421-74472 / **Zaffalon Urbano**, via Santa Croce 2040 Venezia, 041-2750670 / **Global Service Impianti di Cerpelloni & C.**, p.zza Plebiscito 9A Avesa, 045-8342935 / **Video Service**, Via Vitruvio Verona, 045-566299 / **DL service di dal Lago Lorenzo**, Via Giaretta 33 Vicenza, 0444-566662 / **Speedy service**, V.le Europa 42/b Thiene, 0445.368235

ESPANA - <http://www.sharp.es>

En caso de una reclamación con vuestra SHARP Microwave, preguntan por favor la casa dónde han comprado su máquina o infórmanse en una de las SHARP Service casas siguientes.

ALAVA: **Merino Nicolas Jose A.**, Av Judizmendi 24, Vitoria-Gasteiz, 945/ 25.18.92

ALBACETE: **Juman**, Cl Ejercito 1, Albacete, 967/ 22.40.78 / **Parreño**, Cl Santiago Rusiñol 50, Albacete, 967/ 22.62.49

ALICANTE: **A.E. De Consumo**, Cl Peru 42, Alcoy, 96/ 552.32.35 / **David Torregrosa Jorda**, Cl Terrassa 6, Alcoy, 965/ 33.43.06 / **Eurosat, S.L.**, Cl Montero Rios 33, Alicante, 96/ 525.80.40 / **Angel Avellan Puig**, Cl Poeta Quintana 13, Alicante, 965/ 21.32.55 / **Joaquin Saez Servicios**, Cl Escorpion 6-8, Alicante, 96/ 528.73.33 / **Video Electronica Noguera**, Cl Castellon 17, Altea, 965/ 84.41.58 / **Tele-Color**, Cl Del Vent 9, Benidorm, 96/ 585.24.60 / **Joaquin A. Lon Jaen**, Cl Patricio Ferrandiz 66, Denia, 96/ 578.67.50 / **Trinitario Gea**, Cl Jaime Pomares Javaloyes 47, Elche, 96/ 545.56.25 / **Unisat**, Cl Duque De Tamames 9, Orihuela, 96/ 674.11.94 / **Jose A. Patiño Villena**, Cr De Bigastro 1, Orihuela, 96/ 571.74.29 / **Electroservicios Plaza**, Pz Santiago 5, Orihuela, 96/ 828.45.67 / **E.Electrosax**, Cl Rio Turia 1, Sax, 96/ 547.42.32 / **Electronica Santa Pola**, Cl Orihuela 43, Torrevieja, 96/ 571.25.58 / **A.T. Tv. Video**, Av De La Constitucion 185 D, Villena, 965/ 80.02.31

ALMERIA: **Televideo**, Cl Velazquez 7 Local-A, Adra, 950/ 40.18.63 / **Servirap**, Cl Angel Ochotonera 11, Almeria, 950/ 27.40.67 / **Sonivitel S.L.**, Cl Poeta Paco Aquino 51, Almeria, 950/ 22.97.55 / **Servicio Tecnico Ponce**, Plg Ps Maritimo E- Europa 1, Garrucha, 950/ 13.28.37

ASTURIAS: **Asturservice**, Cl Sanchez Calvo 6 Bjos., Aviles, 98/ 556.83.87 / **S.A.T. Juan-Manuel**, Cl Uria 60, Cangas De Narcea, 98/ 581.22.48 / **Manuel Alea Villa**, Cl Llano Margolles S/N, Cangas De Onis, 98/ 592.26.40 / **Electronica Edimar, S.A.**, Cl Cangas De Onis 4, Gijon, 98/ 535.34.51 / **Astusetel S.L.**, Cl Cea Bermudez 9, Gijon, 98/ 539.10.11 / **Juan Morillon Del Corro**, Av De Gijon 19, La Felguera/Langreo, 98/ 567.40.24 / **Santiago Valderrey**, Cl Dr. Venancio Mtez. 7, Navia, 98/ 563.18.61 / **Alvarez Olivar Casilda**, Cl San Jose 12, Oviedo, 98/ 522.37.39 / **G.A.M.I.F.E.L.**, Cl Ricardo Montes 6, Oviedo, 98/ 528.43.60

AVILA: **Daniel Serrano Labrado**, Cl Jose Gochicoa 16, Arenas De S.Pedro, 920/ 37.15.16 / **Electronica Gredos**, Cl Eduardo Marquina 24, Avila, 920/ 22.48.39 / **Reparaciones San Segundo**, Cl Soria 6, Avila, 920/ 22.33.21

BADAJOS: **Indalecio Amaya Sanchez**, Cl Carreras 11, Almendralejo, 924/ 66.47.01 / **Electronica Bote**, Pz Portugal 2, Badajoz, 924/ 22.17.40 / **Patricio Electronica**, Cl Reyes Huertas 7, Merida, 924/ 33.04.13 / **Electronica Centeno S.L.**, Av Del Zafra 1, Puebla Sancho Perez, 924/ 57.53.08 / **C.E. Vilanovense C.B.**, Cl Camino Magacela 4 Local-5, Villanueva Serena, 924/ 84.59.92

BALEARES (MENORCA): **Insat, Cb**, Cl Pintor Calbo 30, Mahon, 971/ 36.53.18

• ADDRESSES D'ENTRETIEN • ONDERHOUDSADRESSEN • DIRECCIONES DE SERVICIO • INDIRIZZI DI SERVIZIO •

- BALEARES (IBIZA): Reparaciones Ortega**, Cl Via Punica 33, Ibiza, 971/ 39.01.55
- BALEARES (MALLORCA): Instalaciones Maes, S.L.**, Cl Son Nadal 63, Palma De Mallorca, 971/ 27.49.47
- BARCELONA: Servinters, S.C.C.L.**, Pz Casagemes 20, Badalona, 93/ 389.44.60 / **Fermo**, Av Morera 5, Badalona, 93/ 465.22.00 / **Videocolor**, Cl Villarreal 44, Barcelona, 93/ 454.99.08 / **4 En 1 Reparaciones**, Cl Taquígrafo Martí 19, Barcelona, 93/ 430.97.26 / **La Clinica Del Electrodo.**, Cl Balmes 160, Barcelona, 93/ 236.44.11 / **Pulgar I Edo S.L.**, Cl Castillejos 333, Barcelona, 93/ 436.44.11 / **Domotica**, Av Diagonal 296, Barcelona, 93/ 408.66.22 / **Estarlich**, Cl Industria 131, Calella, 93/ 766.22.33 / **Joaquín Casajaona Pages**, Cl Major 19 (Tienda), Castelletfells, 93/ 664.43.60 / **Electronica Mateos**, Cr De Caldas (Bajos) 76, Granollers, 93/ 849.28.77 / **Teelco**, Av Balmes 90, Igualada, 93/ 805.11.90 / **Elde**, Cl Bruch 55, Manresa, 93/ 872.85.42 / **Totvisio Electronica S.L.**, Pj Ferrer 14, Manresa, 93/ 873.88.81 / **Ramon Villaret De Gea**, Cl Moli De Vent 21, Mataro, 93/ 798.02.48 / **Estarlich**, Cl Auquebisbe Creus 12, Mataro, 93/ 790.22.89 / **Salja & Mat**, Cl La Raseta 15 L-3, Molins De Rey, 93/ 668.13.61 / **Ce.Va.Sat**, Ps Rubio I Ors 105, Sabadell, 93/ 710.76.13 / **Servei Tecnic Ferrer**, Cl Sarda 37, Sabadell, 93/ 710.51.38 / **Fix Servicio Tecnico**, Cl Valles 88, Sant Cugat Valles, 93/ 675.59.02 / **Ce. Va. Sat, S.C.**, Cr Matadeperra 87, Terrassa, 93/ 785.51.11 / **Laurea S.A.T.**, Cl Guillerries Bis 20, Vic, 93/ 889.02.48 / **Fred Vilafranca**, Cl Progres 42, Vilafranca Del Penedes, 93/ 890.48.52 / **Top Electronica**, Cl Misser Rufet 4 Bjos, Vilafranca Penedes, 93/ 890.35.91
- BILBAO: Telnor**, Pz Juanene 5 Tras., Erandio, 94/ 417.04.97
- BURGOS: Servitec Burgos S.L.**, Cl Lavaderos 7-9, Burgos, 947/ 22.41.68 / **Electronica Mas**, Cl Alfonso Vi 6, Miranda De Ebro, 947/ 31.49.94
- CACERES: Ruiz Garcia Jose**, Cl Ecuador 5-B, Caceres, 927/ 22.48.86 / **Arsenio Sanchez, C.B.**, Cl Tornavacas 9, Plasencia, 927/ 41.11.21 / **Radio Sanchez C.B.**, Av De Miajadas S/N, Trujillo, 927/ 32.06.88
- CADIZ: Jose Borja Y Jose Arana**, Cl San Antonio 31, Algeciras, 956/ 66.60.53 / **Galan Sat S.L.**, Cl Cruz Roja Española 11, Cadiz, 956/ 20.14.17 / **Fermafrio**, Pz España 1, Cadiz, 956/ 28.10.82 / **Novomam-Sat**, Pol. Urbisur, Jorge Juan 4, Chiclana De La Frontera, 956/ 40.12.09 / **Electronica Y Climatizacion Jeda**, Cl Divina Pastora E-1 L-4,5,6, Jerez La Frontera, 956/ 33.64.99 / **Servitel**, Cl Porvenir 11 Local, Jerez La Frontera, 956/ 33.76.55 / **Electrogan**, Cl Pagador 31, Pto. Sta. Maria, 956/ 87.07.05 / **Galan Sat S.L.**, Cl Factoria Matagorda 52, Puerto Real, 956/ 83.35.35 / **Rota Electrosur**, Cl Malaga 11, Rota, 956/ 81.59.60
- CANTABRIA: Electronica Seyma**, Cl Camilo Alonso Vega 48, Santander, 942/ 32.50.60
- CASTELLON: Electronica Maestrat**, Ps Febrer Soriano 65, Benicarlo, 964/ 46.03.08 / **Asiste, S.L.**, Av De Valencia Nave 19, Castellon, 964/ 21.57.69 / **Vensat Reparaciones**, Cl Vinaros 24, Castellon, 964/ 20.57.12
- CEUTA: Pedro A. Carcaño Lopez**, Cl Urano (Local 7), Ceuta, 956/ 50.43.99
- CIUDAD REAL: Tele-Nueva**, Cl Campo 56, Tomelloso, 926/ 50.59.96 / **Electronica Arellano**, Cl Lorenzo Rivas 14, Alcazar De San Juan, 926/ 54.78.95 / **Lara Technitel**, Cl De La Jara 1, Ciudad Real, 926/ 21.17.87 / **Satelec**, Cl Libertad 13, Ciudad Real, 926/ 22.01.55 / **Climatec**, Cl Pozo 3 4º A, Puertollano, 652/ 79.03.60 / **Angel Rodero Bellow**, Cl Asturias 26, Tomelloso, 926/ 51.52.76 / **Electrodiáz S.L.**, Cl Buensuceso 10, Valdepeñas, 926/ 32.23.24
- CORDOBA: Electronica Sales**, Cl Andalucia 11, Aguilar Frontera, 957/ 66.09.04 / **Dueñas Calas Teodoro**, Cl Hermano Juan Fdez 15, Cordoba, 957/ 26.35.06 / **Cayro**, Cl Hermano Juan Fdez. 15, Cordoba, 957/ 26.35.06 / **Microm Electronica**, Av Aeropuerto 2, Cordoba, 957/ 23.02.22 / **Antonio Gonzalez Esquinas**, Cl Gral Primo Rivera 61, Peñarroya, 957/ 57.10.50 / **Serpriego S.L.**, Cl San Luis 4 Bjo. Izda., Priego De Cordoba, 957/ 54.15.11
- GERONA: Reparaciones Pilsa S.C.**, Cl J. Pascual I Prats 8, Gerona, 972/ 20.66.96 / **Feliu Canalías**, Cl Major 26, Campdevanol, 972/ 73.01.72 / **Riera Daviu**, Cl Torras Y Bages 19, Figueres, 972/ 50.32.64 / **Satel**, Ps De Barcelona 12, Olot, 972/ 26.55.19 / **New Meresa**, Cl Surera Bertran 23, Palafrugell, 972/ 30.44.54 / **Arbe Servei**, Av Pompeu Fabra 134, Palafrugell, 696/ 20.14.08
- GRANADA: Servicoستا**, Pz Dr. Alvarez Riosol 1, Almuñecar, 958/ 63.11.43 / **Digmat Electronica**, Av Jose De Mora 16, Baza, 958/ 70.04.52 / **Electronica Wenceslao**, Cl Fontiveros 42, Granada, 958/ 81.16.16 / **Fermasa**, Cl Azorin 7, Granada, 958/ 25.64.77 / **Servigon**, Cl Hospital De La Virgen 22, Granada, 958/ 20.52.81 / **Electronica Vargun**, C./Mozart L-2 Ed.Granate, Granada, 958/ 26.06.01
- GUADALAJARA: Tecnicas Marvi S.L.**, Pz Capitan Boixareu 51, Guadalajara, 949/ 23.27.63 **Ferreteria Toledano**, Cl Ejercito 17 A, Guadalajara, 949/ 23.02.61
- GUIPUZCOA: Teknibat Electronica**, Cl Zezenbide 4, Eibar, 943/ 70.24.37 / **Estudios 3, C.B.**, Pz De Los Estudios 3, San Sebastian, 943/ 45.37.97 / **Reparaciones Urruti S.L.**, Ps Aintzieta 32, San Sebastian, 943/ 45.84.10
- HUELVA: Abril Sanchez Valentin**, Cl Cadiz 2, Cala, 959/ 10.60.41 / **Telejara**, Pol. Polirrosa Cl-A Nave-27, Huelva, 959/ 22.60.74 / **Telesonid Huelva, S.C.A.**, Cl Fco.Vazquez Limon 4, Huelva, 959/ 24.38.60 / **Airsex Huelva**, Ps De La Glorieta 6, Huelva, 959/ 22.88.13 / **Electro Sur**, Cl Alonso De Ercilla 23, Huelva, 959/ 29.06.15
- JAEN: Electronica Gonzalez**, Corredera San Bartolome 11, Andujar, 953/ 50.33.82 / **Electro Himega, S.A.**, Cl Adarves Bajos 4-C, Jaen, 953/ 24.22.56 / **Uniservic Electronica**, Cl Goya 1 Bjos, Ubeda, 953/ 75.14.19
- LA CORUÑA: Ramsat**, Av Finisterre 117-B, Cee, 981/ 74.74.61 / **Zener Electronica**, Cl Ronda De Monte Alto 15, La Coruña, 981/ 22.07.00 / **S.T. Mendez**, Cl Gil Vicente 13, La Coruña, 981/ 27.52.52 / **Bandin Audio**, Cl Rua Arcos Moldes 2 B-3, Rianxo, 981/ 86.60.23 / **Victor Perez Quintela**, Cl Entrerios 35, Santiago De Compostela, 981/ 58.43.92
- LA RIOJA: Top Service**, Cl Achutegui De Blas 17, Calahorra, 941/ 13.50.35 / **Electronica Musand**, Cl Rey Pastor 60-62, Logroño, 941/ 22.84.52 / **Aguado Sat**, Cl Velez De Guevara 26 Bajo, Logroño, 941/ 25.25.53
- LEON: Prosat**, Pz Doce Martires 5, Leon, 987/ 20.34.10 / **Tecnyser Electro**, Cl Relojero Losada 25, Leon, 987/ 22.77.87 / **Asist. Tecnica Marcos**, Cl Conde De Toreno 5, Leon, 987/ 20.01.01 / **Domespa Bierzo**, Cl Batalla De Lepanto 8, Ponferrada, 987/ 41.14.29
- LERIDA: Satef**, Cl Sant Pelegri 54, Tarrega, 973/ 50.08.48 / **Electronica Guirao**, Cl Sant Pere Claver 16 B-2, Tarrega, 973/ 50.02.34 / **Jordi Duro Fort**, Cl Industria 6 3º 3º, Tremp, 973/ 65.25.15
- LLEIDA: Ielsa Electronica**, Cl Tarragona 15, Lleida, 973/ 24.71.27 / **Cristel**, Cl Vallcalent 32, Lleida, 973/ 27.08.26
- LUGO: Televexo S.L.**, Cl Nosa Sra. Do Carmen 82, Burela, 982/58.18.57 / **Servicio Tecnico Pasfer**, Av Arcadio Pardiñas 77, Burela, 696/17.86.458 / **Electronica Penelo**, Cl Serra Gañidoira 63, Lugo, 982/ 21.47.43 / **Electronica Fouces**, Cl Benito Vicetto 34, Monforte De Lemos, 982/ 40.24.38
- MADRID: Video Service Electronic**, Cl Era Honda 9, Alcala De Henares, 91/ 880.27.87 / **Variosat, S.L.**, Cl Isla De Corcega 24, Alcobendas, 91/ 662.04.68 / **Ugenasa**, Cl La Canaleja 4, Alcorcon, 91/ 611.52.51 / **Electronica Barajas**, Pz Del Jubilado 8, Barajas, 91/ 305.48.90 / **Tec-Norte**, Cl Santiago Apostol 5, Collado Villalba, 91/851.63.47 / **Garman C.B.**, Cl Carlos Sole 38 Local, Madrid, 91/380.33.49 / **Electronica Garman, C.B.**, Cl Mandarina 15, Madrid, 91/ 368.01.79 / **Electronica Ansar**, Cl Tomasa Ruiz 4, Madrid, 91/ 460.47.45 / **Elbeservi, S.A.**, Cl Dr.R. Castroviejo 19, Madrid, 91/ 386.27.11 / **Cromadelta**, Cl Alfonso XII 31, Mostoles, 91/ 664.16.41

• ADDRESSES D'ENTRETIEN • ONDERHOUDSADRESSEN • DIRECCIONES DE SERVICIO • INDIRIZZI DI SERVIZIO •

MALAGA: **Servisuel, Edif. La Union**, Cm De Las Cañadas Lc 2, Fuengirola, 952/ 46.90.28 / **Climaire Plus**, Cl Guaro 4, Malaga, 95/ 234.50.36 / **Electronica Garcia Campoy**, Av Velazquez 5, Malaga, 952/ 32.00.77 / **Electronica Bg**, Cl Andalucia 2, San Pedro De Alcantara, 952/ 78.50.09 / **Video Taller, S.C.**, Edif. La Noria B Bjos-5, Torre Del Mar, 952/ 54.23.95

MELILLA: **Sonitev**, Cl Ejercito Español 3, Melilla, 952/ 68.30.80 / **MURCIA: Reg., C.B.**, Cl Ramon Y Cajal 27, Cartagena, 968/ 51.00.06 / **Caro Porlan Raimundo**, Cl Jose Mouliac 45, Lorca, 968/ 46.18.11 / **J. Luis Haro Calvo**, Cl La Seda 8 Edif. Las Terrazas, Lorca, 968/ 47.18.79 / **Electroservicios Seba, C.B.**, Cl Isaac Albeniz 4 Bjos, Murcia, 968/ 29.85.93 / **Visatel**, Cl Torre Alvarez S/N, Murcia, 968/ 24.16.47 / **Electro Servicios Plaza**, Cl Gomez Cortina 10, Murcia, 968/ 28.45.67 / **Angel Lopez Alcaraz**, Cl Sierra Del Espartal 8 (Edif. Ana), Murcia, 968/ 29.39.10 / **Rafael Gomez Yelo**, Ps Corbera 17, Murcia, 968/ 26.14.67

NAVARRA: A. T. Pamplona, Cl Julian Gayarre 1, Pamplona, 948/ 24.19.50 / **Unitec**, Cl Fuente Canonigos 5, Tudela, 948/ 82.74.34

ORENSE: **Fernandez Gonzalez Jose**, Av Buenos Aires 75 Bjos, Orense, 988/ 23.48.53 / **Antonio Rodriguez Alvarez**, Cl Cabeza De Manzaneda 7, Orense, 988/ 22.40.98

PALENCIA: **Electronica Javier**, Av Castilla 77, Palencia, 979/ 75.03.74 / **Multiservicio Palencia**, Cl Cardenal Cisneros 20, Palencia, 979/ 74.53.80

PAMPLONA: **Electro Reparaciones 2000**, Cl Monasterio Fitero 26, Pamplona, 948/ 26.79.12

PONTEVEDRA: **Imason**, Cl Loureiro Crespo 43, Pontevedra, 986/ 84.16.36 / **Central De Servicios**, Cl Asturias (Bajo) 10, Vigo, 986/ 37.47.45 / **Sial-Alvimo S.L.**, C/ C.Torrecedeira 92 Bjos, Vigo, 986/ 29.93.01 / **Electronica Cambados**, Cl Camilo Jose Cela 13, Vilagarcia Arousa, 986/ 50.83.27

SALAMANCA: **Almat Electronica**, Cl Galileo 21, Salamanca, 923/ 22.45.08 / **J. Daniel Martinez**, Cl Abraham Lacut 11-15, Salamanca, 923/ 19.16.10

SEGOVIA: **Guijo S.T.**, Cl Teofilo Ayuso 2 Local, Segovia, 921/ 42.94.18

SEVILLA: **Electro 93 S.L.**, Cl Melliza 1, Dos Hermanas, 95/ 472.37.16 / **Electronica Bersabe**, Pasaje Merinos 62 A, Ecija, 95/ 483.33.93 / **Electronica Guillen**, Cl La Cilla 70, Osuna, 954/ 81.12.96 / **Electronica Triana**, Cl Evangelista 69-71 L-25, Sevilla, 95/ 433.83.03 / **Telepal**, Cl Julio Verne 49, Sevilla, 95/ 464.95.80 / **Auvitel, S.L.**, Cl Virgen De Africa 20, Sevilla, 95/ 427.57.07 / **Luis Rivas Caldas**, Cl Febo 16, Sevilla, 95/ 451.73.55 / **Intersat Sevilla**, Cl Beethoven 5, Sevilla, 95/ 443.02.26 / **Frilar**, Pol. Indust. Navisa C/A 47, Sevilla, 95/ 492.14.44 / **Televideo Nervion**, Cl Juan Curiel 22, Sevilla, 95/ 458.10.66

SORIA: **Teco**, Cl Antolin De Soria 10, Soria, 975/ 22.61.25

TARRAGONA: **Selecco S.L.**, Cl Calderon De La Barca 11, Amposta, 977/ 70.00.12 / **Mañe Grifolls**, Cl Jesus 21, Calafell, 977/ 69.04.39 / **Tecno Serveis Mora**, Cl Pau Picasso 1, Mora D'ebre, 977/ 40.08.83 / **Euro Tecnicos Electronica**, Cl Lepanto 16-18, Reus, 977/ 32.24.89 / **Martorell Altes Francisco**, Cl Roseta Mauri 10, Reus, 977/ 75.32.41 / **Electronica Loguard**, Cl Vapor Vell 17, Reus, 977/ 32.38.04 / **Electronica S. Torres**, Cl Ernest Vilches 4-B L-2, Tarragona, 977/ 21.21.48 / **Sertecs, S.C.**, Cl Caputxins (Bajos) 22, Tarragona, 977/ 22.18.51 / **Electro Servei C.B.**, Ps Moreira 10, Tortosa, 977/ 51.04.42

TERUEL: **Electronica Alcañiz S.L.**, Cl Carmen 21, Alcañiz, 979/ 87.07.94 / **Teleservicio Bajo Aragon**, Cl Romualdo Soler 4, Alcañiz, 978/ 87.08.10 / **Alejandro Hernandez**, Rb San Julian 59, Teruel, 978/ 60.85.51

TOLEDO: **Electro Anaya**, Cl Vertedera Alta 14, Consuegra, 925/ 48.09.81 / **Electronica Rivas**, Cl Barrio San Juan 1, Talavera La Reina, 925/ 80.55.46 / **Electronica Fe-Car, S.L.**, Av Santa Barbara 30, Toledo, 925/ 21.21.45 / **Electronica Jopal S.L.**, Av Santa Barbara S/N, Toledo, 925/ 25.04.42

VALENCIA: **Envisa Electronic, S.L.**, Cl General Espartero 9, Alzira, 96/ 241.24.87 / **Tecno Hogar**, Cl Dos De Mayo 41, Gandia, 96/ 286.53.35 / **Electro Servis**, Cl Grupo San Valero 4-6, Sueca, 96/ 170.38.50 / **Frifonta**, Cl Actor Llorens 3, Valencia, 96/ 369.92.66 / **Servicios Electronicos**, Cl Doctor Oloriz 3, Valencia, 96/ 340.20.34 / **Antonio Monleon, S.L.**, Av De La Plata 91, Valencia, 96/ 334.55.87

VALLADOLID: **Electronica Vitelson**, Pz Del Mercado 9, Medina Del Campo, 983/ 80.43.56 / **Teleservicios**, Cl Esgueva 6, Valladolid, 983/ 30.92.61 / **Asist. Tecnica Marcos**, Cl Pio Del Rio Horteiga 2-4, Valladolid, 983/ 29.78.66 / **Jesus Alburquerque**, Cl Vinos Ribera Del Duero 10, Valladolid, 983/ 24.62.26 / **Teodoro Negro Hernandez**, Glorieta Descubrimiento 4, Valladolid, 983/ 39.17.81

VIZCAYA: **Servitele**, Cl Autonomia 24 Galerias, Bilbao, 94/ 444.89.02 / **Negredo Martin Daniel**, Cl Padre Pernet 8, Bilbao, 94/ 411.22.82 / **Collantes Martin Onofre**, Cl Ortuño De Alango 7, Portugalete, 94/ 483.21.22

ZAMORA: **R.T.V. Blanco**, Cl Eduardo Julian Perez 9, Zamora, 980/ 51.14.41

ZARAGOZA: **Cinca Monterde Antonio**, Cl Via Universitat 52, Zaragoza, 976/ 31.69.65 / **Aragon Televideo, S.C.**, Cl Batalla Clavijo 18, Zaragoza, 976/ 32.97.12

SWITZERLAND - <http://www.sharp.ch>

Sharp Electronics AG, Langwiesenstrasse 7, CH-8108 Dällikon, +41 1 846 61 11

SWEDEN - <http://www.sharp.se>

Bild&Ljudservice, Roxviksgatan 8, 582 73 Linköping, 013-356250 / **Jönköping Antenn & TV Service**, Fridhemsvägen 20, 553 02 Jönköping, 036-161690 / **Tomte Elektronik**, Svandammsplan 2, 126 47 Hägersten, 08-186170 / **Tv Trim**, St Pauligatan 37, 416 90 Göteborg, 031-847200 / **Tv-berg**, Krusegatan 26, 212 25 Malmö, 040-188380

NORWAY

Service Eksperten, Trondheimsvn 436B, N-0962 Oslo, 22 90 19 30

ICELAND

Braedurnir Ormsson Ltd, PO box 8790, IS-128 Reykjavik, +354-5332800
Hjoltmaekni Ehf, Skeifar, IS-108 Reykjavik, +354-5332150

DENMARK

Elektronik Centret, Literbuen 10A, DK2740 Skovlunde, 44 50 30 00

SUOMI

Oy Perkko, PL 40 Rälssintie 6, SF-00721 Helsinki, +35-8947805000
Theho Video Oy, Niityläntie 3, SF-0620 Helsinki, +35-891461500



GB

SPECIFICATIONS

GB

AC Line Voltage	: 230 V, 50 Hz, single phase
Distribution line fuse/circuit breaker	: Minimum 16 A
AC Power required:	Microwave : 1,45 kW Top Grill : 1,00 kW Microwave / Top Grill : 2,40 kW Bottom Grill : 0,55 kW Microwave / Bottom Grill : 1,95 kW Top & Bottom Grills : 1,50 kW Convection : 1,525 kW Microwave / Convection : 2,90 kW
Output power:	Microwave : 900 W (IEC 60705) Top Grill : 0,95 kW Bottom Grill : 0,5 kW Convection : 1,45 kW
Microwave Frequency	: 2450 MHz * (Group 2/Class B)
Outside Dimensions	: 520 mm (W) x 309 mm (H) x 488 mm (D)
Cavity Dimensions	: 349 mm (W) x 207 mm (H) x 357 mm (D) **
Oven Capacity	: 26 litres **
Turntable	: ø325 mm, metal
Weight	: 20 kg
Oven lamp	: 25 W/240 - 250 V

- * This Product fulfils the requirement of the European standard EN55011.
 In conformity with this standard, this product is classified as group 2 class B equipment.
 Group 2 means that the equipment intentionally generates radio-frequency energy in the form of electromagnetic radiation for the heat treatment of food.
 Class B equipment means that the equipment is suitable to be used in domestic establishments.
- ** Internal capacity is calculated by measuring maximum width, depth and height.
 Actual capacity for holding food is less.



This equipment complies with the requirements of directives 89/336/EEC and 73/23/EEC as amended by 93/68/EEC.

As part of a policy of continuous improvement, we reserve the right to alter design and specifications without notice.

ENGLISH

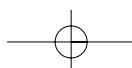

SHARP

SHARP ELECTRONICS (EUROPE) GMBH.

Sonninstrasse 3
20097 Hamburg
Germany

Gedruckt in Grossbritannien

Imprimé au Royaume-Uni

Gedruckt in Groot-Brittannie

Stampato in Gran Bretagna

Impreso en el Reino Unido



*Der Zellstoff zur
Herstellung dieses
Papiers kommt zu
100 % aus nachhaltig
bewirtschafteten
Wäldern*

*Ce papier est
entièrement fabriqué
à partir de pâte à
papier provenant
de forêts durables*

*De pulp die gebruik is
voor de vervaardiging
van dit papier is voor
100 % afkomstig uit
bossen die doorlopend
opnieuw aangepland
worden*

*Il 100 % della pasta
utilizzata per
produrre questa carta
provieni da foreste
sostenibili*

*El 100 % de la
pasta utilizada en
la fabricación de
este papel procede
de bosques
sostenibles*

TINS-A432URRO

SHARP

SHARP ELECTRONICS (EUROPE) GMBH.

Sonninstrasse 3
20097 Hamburg
Germany

Gedruckt in Grossbritannien

Imprimé au Royaume-Uni

Gedruckt in Groot-Brittannie

Stampato in Gran Bretagna

Impreso en el Reino Unido



*Das Papier dieser
Bedienungsanleitung
besteht zu 100 %
aus Altpapier*

*Le papier de ce
mode d'emploi est
fait de 100 %
de papier réutilisé*

*De papier voor deze
gebruiksaanwijzing
is van 100 %
hergebruiken papier
gemaakt*

*La carta di questo
manuale d'istruzioni
è fatta di 100 %
della carta riciclata*

*El papel de este
manual de
instrucciones se
hace de 100 %
es del papel
reciclado*

TINS-A432URRO